

# Spannzangen

## Collets



### ■ Inhalt:

- | DIN 6388B / OZ (doppelt geschlitzt)
- | DIN 6388A / OZ (einfach geschlitzt)
- | DIN 6499 / ER / ESX (ER 8 - ER 50)
- | DIN 6499 / ER / ESX, Präzisionsausführung (ER 8 - ER 40)
- | DIN 6499 / ER / ESX, abgedichtet (ER 11 - ER 40)
- | Gewindebohrzangen mit Innenvierkant (ER 16 - ER 50)
- | Gewindebohrzangen mit Längenausgleich
- | Spannzangen Erickson, Typ DK
- | Typ 385 E (5C), Typ 369 E (R8)
- | Direktspannzangen
- | DIN 6343 (161 E, 163 E, 173 E, 185 E, 193 E)
- | Spannköpfe
- | Spannzangensätze
- | Anschlagschrauben
- | Aluminiumkoffer

### ■ Content:

- | *DIN 6388B / OZ (double slotted)*
- | *DIN 6388A / OZ (single slotted)*
- | *DIN 6499 / ER / ESX (ER 8 - ER 50)*
- | *DIN 6499 / ER / ESX, precision design (ER 8 - ER 40)*
- | *DIN 6499 / ER / ESX, sealed (ER 11 - ER 40)*
- | *Tapping collets with internal square (ER 16 - ER 50)*
- | *Tapping collets with length compensation*
- | *Collet Erickson, Type DK*
- | *Type 385 E (5C), type 369 E (R8)*
- | *Taper collets*
- | *DIN 6343 (161 E, 163 E, 173 E, 185 E, 193 E)*
- | *Clamping heads*
- | *Collet sets*
- | *Stop screws*
- | *Aluminium cases*

## Spannzangen OZ, DIN 6388B, doppelt geschlitzt Collets OZ, DIN 6388B, double slotted

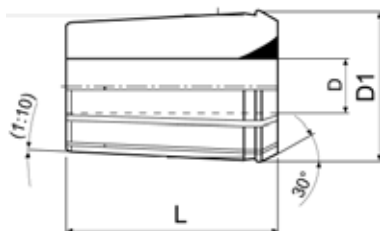

### Typ 415 E (OZ 16), 0,5 mm steigend / stepped

D mm	D1 mm	L mm	Art.-Nr. / Order no.
2-16	25,5	40	06-415E-Ø

### Typ 4541 E (OZ 20), 1 mm steigend / stepped

D mm	D1 mm	L mm	Art.-Nr. / Order no.
2-20	29,8	45	06-4541E-Ø

### Typ 462 E (OZ 25), 0,5 mm steigend / stepped

D mm	D1 mm	L mm	Art.-Nr. / Order no.
2-25	35,5	52	06-462E-Ø

### Typ 467 E (OZ 32), 0,5 mm steigend / stepped

D mm	D1 mm	L mm	Art.-Nr. / Order no.
3-32	43,7	60	06-467E-Ø

### Typ 468 E (OZ 40), 1 mm steigend / stepped

D mm	D1 mm	L mm	Art.-Nr. / Order no.
12-40	52,2	68	06-468E-Ø

## Spannzangen OZ, DIN 6388A, einfach geschlitzt Collets OZ, DIN 6388A, single slotted



### Typ 401 E (OZ 8), 0,5 mm steigend / stepped

D mm	D1 mm	L mm	Art.-Nr. / Order no.
1,0-2,5	14,5	26	06-401E-Ø
3,0-8,0	14,5	26	06-401E-Ø

### Typ 410 E (OZ 16), 1 mm steigend / stepped

D mm	D1 mm	L mm	Art.-Nr. / Order no.
2-16	25,5	40	06-410E-Ø

### Typ 444 E (OZ 25), 1 mm steigend / stepped

D mm	D1 mm	L mm	Art.-Nr. / Order no.
2-25	35,5	52	06-444E-Ø

### Typ 450 E (OZ 32), 1 mm steigend / stepped

D mm	D1 mm	L mm	Art.-Nr. / Order no.
4-32	44	60	06-450E-Ø

- Lagerstandard / in stock
- ▶ innerhalb weniger Tage / within a few days
- auf Anfrage / on request
- \* auslaufende Größe / as stock lasts

# Spannzangen ER/ESX, DIN 6499

## Collets ER/ESX, DIN 6499

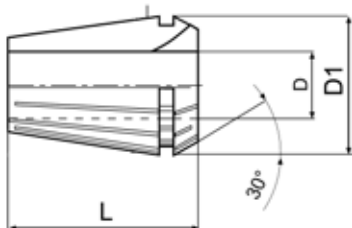

### ER 8 (4004 E), 0,5 mm steigend / stepped

D mm	D1 mm	L mm	Art.-Nr. / Order no.
1-5	8,5	13,5	09-9008-Ø

### ER 11 (4008 E), 0,5 mm steigend / stepped

D mm	D1 mm	L mm	Art.-Nr. / Order no.
1-7	11,5	18	09-9011-Ø

### ER 16 (426 E), 0,5 mm steigend / stepped

D mm	D1 mm	L mm	Art.-Nr. / Order no.
1-10	17	27,5	09-9016-Ø

### ER 20 (428 E), 0,5 mm steigend / stepped

D mm	D1 mm	L mm	Art.-Nr. / Order no.
1-2,5	21	31,5	09-9020-Ø
3-13	21	31,5	09-9020-Ø

### ER 25 (430 E), 0,5 mm steigend / stepped

D mm	D1 mm	L mm	Art.-Nr. / Order no.
1-2,5	26	34	09-9025-Ø
3-16	26	34	09-9025-Ø

### ER 32 (470 E), 0,5 mm steigend / stepped

D mm	D1 mm	L mm	Art.-Nr. / Order no.
1-2,5	33	40	09-9032-Ø
3-20	33	40	09-9032-Ø

### ER 40 (472 E), 1 mm steigend / stepped

D mm	D1 mm	L mm	Art.-Nr. / Order no.
3-26	41	46	09-9040-Ø
27-30	41	46	09-9040-Ø

### ER 50 (477 E), 1 mm steigend / stepped

D mm	D1 mm	L mm	Art.-Nr. / Order no.
6-34	52	60	09-9050-Ø

# Präzisionsausführung, Spannzangen ER/ESX, DIN 6499

## Precision design, collets ER/ESX, DIN 6499

D min. mm	D max. mm	Prüflänge	Rundlauf / Runout
1	1,5	6	0,010
2	3	10	0,008
3,5	7	16	0,008
7,5	10	25	0,008
10,5	18	40	0,010
18,5	26	50	0,010

### ER 8 (4004 E) - Präzision / precision, 0,5 mm steigend / stepped

D mm	D1 mm	L mm	Art.-Nr. / Order no.
1-2,5	8,5	13,5	● 09-9008-ØUP
3-5	8,5	13,5	● 09-9008-ØUP

### ER 11 (4008 E) - Präzision / precision, 0,5 mm steigend / stepped

D mm	D1 mm	L mm	Art.-Nr. / Order no.
1-2,5	11,5	18	● 09-9011-ØUP
3-7	11,5	18	● 09-9011-ØUP

### ER 16 (426 E) - Präzision / precision, 0,5 mm steigend / stepped

D mm	D1 mm	L mm	Art.-Nr. / Order no.
1-2,5	17	27,5	● 09-9016-ØUP
3-10	17	27,5	● 09-9016-ØUP

### ER 20 (428 E) - Präzision / precision, 1 mm steigend / stepped

D mm	D1 mm	L mm	Art.-Nr. / Order no.
1-2	21	31,5	● 09-9020-ØUP
3-13	21	31,5	● 09-9020-ØUP

### ER 25 (430 E) - Präzision / precision, 1 mm steigend / stepped

D mm	D1 mm	L mm	Art.-Nr. / Order no.
1-2	26	34	● 09-9025-ØUP
3-16	26	34	● 09-9025-ØUP

### ER 32 (470 E) - Präzision / precision, 1 mm steigend / stepped

D mm	D1 mm	L mm	Art.-Nr. / Order no.
2	33	40	● 09-9032-2,0UP
3-20	33	40	● 09-9032-ØUP

### ER 40 (472 E) - Präzision / precision, 1 mm steigend / stepped

D mm	D1 mm	L mm	Art.-Nr. / Order no.
3-26	41	46	● 09-9040-ØUP

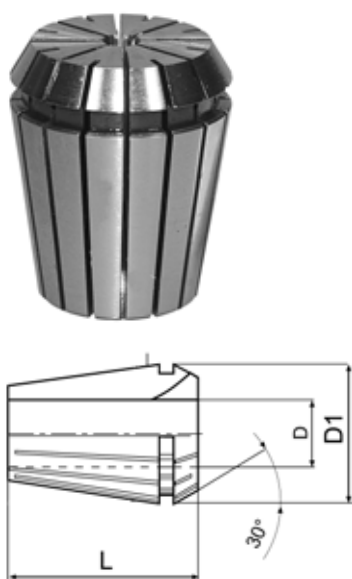

**PRÄZISION /  
PRECISION**

Spannzangen abgedichtet ER/ESX, DIN 6499, 1 mm steigend  
 Sealed collets ER/ESX, DIN 6499, 1 mm stepped

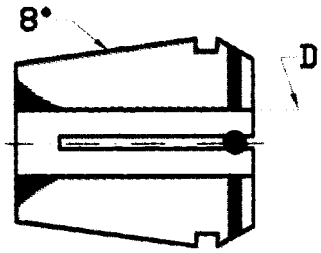

**ABGEDICHTET /  
 SEALED**

**ER 11 (4012 E) - abgedichtet / sealed**

D mm	Art.-Nr. / Order no.
3 - 7 mm	09-9011-ØS

**ER 16 (425 E) - abgedichtet / sealed**

D mm	Art.-Nr. / Order no.
3 - 10 mm	09-9016-ØS

**ER 20 (427 E) - abgedichtet / sealed**

D mm	Art.-Nr. / Order no.
3 - 13 mm	09-9020-ØS

**ER 25 (429 E) - abgedichtet / sealed**

D mm	Art.-Nr. / Order no.
3 - 16 mm	09-9025-ØS

**ER 32 (469 E) - abgedichtet / sealed**

D mm	Art.-Nr. / Order no.
3 - 20 mm	09-9032-ØS

**ER 40 (471 E) - abgedichtet / sealed**

D mm	Art.-Nr. / Order no.
4 - 26 mm	09-9040-ØS



## Gewindebohrzangen mit Innenvierkant Tapping collets with internal square

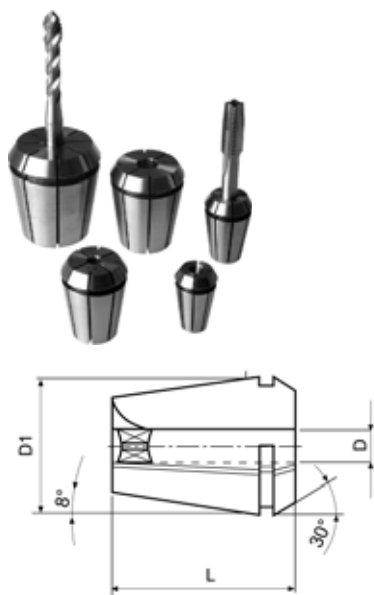

### ER 16-GB mit Innenvierkant ER 16-GB with internal square

D x □ mm	D1 mm	L mm	Art.-Nr. / Order no.
3,5 x 2,7	16	27,5	● 09-8016-3,5
4 x 3	16	27,5	● 09-8016-4,0
4,5 x 3,4	16	27,5	● 09-8016-4,5
5 x 5	16	27,5	● 09-8016-5,0
5,5 x 4,3	16	27,5	● 09-8016-5,5
6 x 4,9	16	27,5	● 09-8016-6,0
7 x 5,5	16	27,5	● 09-8016-7,0
8 x 6,2	16	27,5	● 09-8016-8,0
9 x 7	16	27,5	● 09-8016-9,0

### ER 20-GB mit Innenvierkant ER 20-GB with internal square

D x □ mm	D1 mm	L mm	Art.-Nr. / Order no.
3,5 x 2,7	20	31,5	● 09-8020-3,5
4 x 3	20	31,5	● 09-8020-4,0
4,5 x 3,4	20	31,5	● 09-8020-4,5
5 x 5	20	31,5	● 09-8020-5,0
5,5 x 4,3	20	31,5	● 09-8020-5,5
6 x 4,9	20	31,5	● 09-8020-6,0
7 x 5,5	20	31,5	● 09-8020-7,0
8 x 6,2	20	31,5	● 09-8020-8,0
9 x 7	20	31,5	● 09-8020-9,0
10 x 8	20	31,5	● 09-8020-10,0
11 x 9	20	31,5	● 09-8020-11,0
12 x 9	20	31,5	● 09-8020-12,0

### ER 25-GB mit Innenvierkant ER 25-GB with internal square

D x □ mm	D1 mm	L mm	Art.-Nr. / Order no.
3,5 x 2,7	25	34	● 09-8025-3,5
4 x 3	25	34	● 09-8025-4,0
4,5 x 3,4	25	34	● 09-8025-4,5
5 x 5	25	34	● 09-8025-5,0
5,5 x 4,3	25	34	● 09-8025-5,5
6 x 4,9	25	34	● 09-8025-6,0
7 x 5,5	25	34	● 09-8025-7,0
8 x 6,2	25	34	● 09-8025-8,0
9 x 7	25	34	● 09-8025-9,0
10 x 8	25	34	● 09-8025-10,0
11 x 9	25	34	● 09-8025-11,0
12 x 9	25	34	● 09-8025-12,0
14 x 11	25	34	● 09-8025-14,0
16 x 12	25	34	● 09-8025-16,0

Abgedichtete Gewindebohrzangen auf Anfrage lieferbar  
Sealed tapping collets available upon request

- Lagerstandard / in stock
- ▶ innerhalb weniger Tage / within a few days
- auf Anfrage / on request
- \* auslaufende Größe / as stock lasts

# Gewindebohrzangen mit Innenvierkant

## Tapping collets with internal square

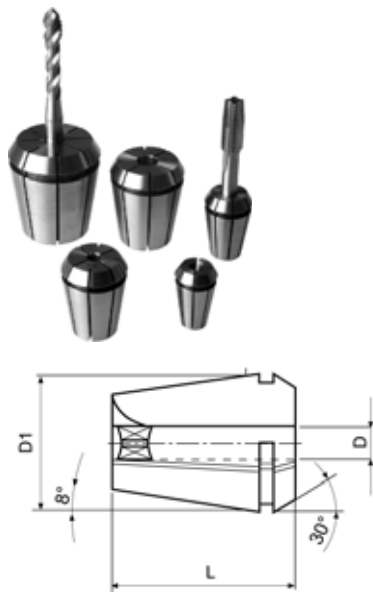

### ER 32-GB mit Innenvierkant

#### ER 32-GB with internal square

D x □ mm	D1 mm	L mm	Art.-Nr. / Order no.
3,5 x 2,7	32	40	● 09-8032-3,5
4 x 3	32	40	● 09-8032-4,0
4,5 x 3,4	32	40	● 09-8032-4,5
5 x 5	32	40	● 09-8032-5,0
5,5 x 4,3	32	40	● 09-8032-5,5
6 x 4,9	32	40	● 09-8032-6,0
7 x 5,5	32	40	● 09-8032-7,0
8 x 6,2	32	40	● 09-8032-8,0
9 x 7	32	40	● 09-8032-9,0
10 x 8	32	40	● 09-8032-10,0
11 x 9	32	40	● 09-8032-11,0
12 x 9	32	40	● 09-8032-12,0
14 x 11	32	40	● 09-8032-14,0
16 x 12	32	40	● 09-8032-16,0
18 x 14,5	32	40	● 09-8032-18,0
20 x 16	32	40	● 09-8032-20,0

### ER 40-GB mit Innenvierkant

#### ER 40-GB with internal square

D x □ mm	D1 mm	L mm	Art.-Nr. / Order no.
6 x 4,9	40	46	● 09-8040-6,0
7 x 5,5	40	46	● 09-8040-7,0
8 x 6,2	40	46	● 09-8040-8,0
9 x 7	40	46	● 09-8040-9,0
10 x 8	40	46	● 09-8040-10,0
11 x 9	40	46	● 09-8040-11,0
12 x 9	40	46	● 09-8040-12,0
14 x 11	40	46	● 09-8040-14,0
16 x 12	40	46	● 09-8040-16,0
18 x 14,5	40	46	● 09-8040-18,0
20 x 16	40	46	● 09-8040-20,0
22 x 18	40	46	● 09-8040-22,0

### ER 50-GB mit Innenvierkant

#### ER 50-GB with internal square

D x □ mm	D1 mm	L mm	Art.-Nr. / Order no.
8 x 6,2	50	60	* 09-8050-8,0
9 x 7	50	60	* 09-8050-9,0
10 x 8	50	60	* 09-8050-10,0
11 x 9	50	60	* 09-8050-11,0
12 x 9	50	60	* 09-8050-12,0
14 x 11	50	60	* 09-8050-14,0
16 x 12	50	60	* 09-8050-16,0
18 x 14,5	50	60	* 09-8050-18,0
20 x 16	50	60	* 09-8050-20,0
22 x 18	50	60	* 09-8050-22,0
25 x 20	50	60	* 09-8050-25,0
28 x 22	50	60	* 09-8050-28,0
32 x 24	50	60	* 09-8050-32,0

Abgedichtete Gewindebohrzangen auf Anfrage lieferbar  
Sealed tapping collets available upon request

# Gewindebohrzangen mit Längenausgleich

## Tapping collets with length compensation

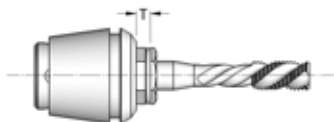
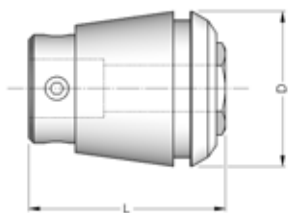

### Gewindebohrzangen ER mit Längenausgleich

#### Tapping collets ER with length compensation

SZ / Collet	Spann-Ø / Clamping-Ø mm	D mm	L mm	T mm	Art.-Nr. / Order no.
ER 16	Ø 2,5 - Ø 6,0	17	27	7	● 09-6016-Ø
ER 20	Ø 2,8 - Ø 7,0	21	31	7	● 09-6020-Ø
ER 25	Ø 2,5 - Ø 10,0	26	34	8	● 09-6025-Ø
ER 32	Ø 4,5 - Ø 12,0	33	43	10	● 09-6032-Ø
ER 40	Ø 6,0 - Ø 16,0	41	54	13	● 09-6040-Ø

SZ / Collet	Standard-Ø / Standard-Ø mm
ER 16	2,5 / 2,8 / 3,5 / 4,5 / 6,0
ER 20	2,8 / 3,5 / 4,5 / 6,0 / 7,0
ER 25	2,5 / 2,8 / 3,5 / 4,5 / 6,0 / 7,0 / 8,0 / 9,0 / 10,0
ER 32	4,5 / 6,0 / 7,0 / 8,0 / 9,0 / 10,0 / 11,0 / 12,0
ER 40	6,0 / 7,0 / 8,0 / 9,0 / 10,0 / 11,0 / 12,0 / 14,0 / 16,0

Andere Abmessungen lieferbar auf Anfrage  
Further dimensions available upon request

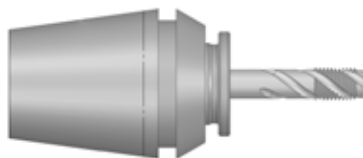
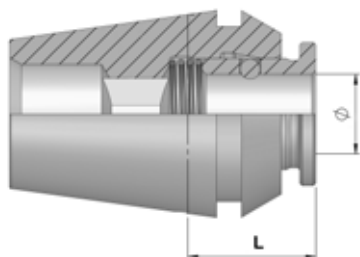

### Gewindebohrzangen ER ohne Längenausgleich, mit Schnellwechselsystem

#### Tapping collets ER without length compensation, with quick-change system

SZ / Collet	Spann-Ø / Clamping-Ø mm	D mm	L mm	Art.-Nr. / Order no.
ER 16	Ø 3,5 - Ø 6,0	17	11	● 09-5016-Ø
ER 20	Ø 3,5 - Ø 7,0	21	17	● 09-5020-Ø
ER 25	Ø 3,5 - Ø 10,0	26	18,5	● 09-5025-Ø
ER 32	Ø 4,5 - Ø 12,0	33	18,5	● 09-5032-Ø
ER 40	Ø 6,0 - Ø 16,0	41	19	● 09-5040-Ø

SZ / Collet	Standard-Ø / Standard-Ø mm
ER 16	3,5 / 4,5 / 6,0
ER 20	3,5 / 4,5 / 6,0 / 7,0
ER 25	3,5 / 4,5 / 6,0 / 7,0 / 8,0 / 9,0 / 10,0
ER 32	4,5 / 6,0 / 7,0 / 8,0 / 9,0 / 10,0 / 11,0 / 12,0
ER 40	6,0 / 7,0 / 8,0 / 9,0 / 10,0 / 11,0 / 12,0 / 14,0 / 16,0

Andere Abmessungen lieferbar auf Anfrage  
Further dimensions available upon request



# Spannzangen Typ Erickson Collets type Erickson



## Typ 412 E (DK-S), 0,25 mm steigend / stepped

D mm	D1 mm	L mm	Art.-Nr. / Order no.
1-2	6,8	16,3	▶ 06-412E-Ø
2,25-3	6,8	16,3	▶ 06-412E-Ø
3,25-4	6,8	16,3	▶ 06-412E-Ø

## Typ 416 E (DK30), 0,5 mm steigend / stepped

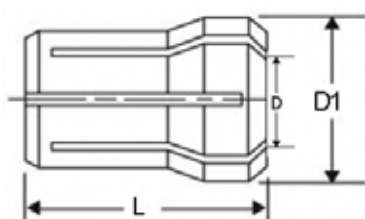

D mm	D1 mm	L mm	Art.-Nr. / Order no.
1-2,5	9,5	25,4	▶ 06-416E-Ø
3-6,5	9,5	25,4	▶ 06-416E-Ø

## Typ 417 E (DK20), 0,5 mm steigend / stepped

D mm	D1 mm	L mm	Art.-Nr. / Order no.
1-2,5	13,6	30,3	▶ 06-417E-Ø
3-10	13,6	30,3	▶ 06-417E-Ø

## Typ 418 E (DK10), 0,5 mm steigend / stepped

D mm	D1 mm	L mm	Art.-Nr. / Order no.
1-2,5	19,4	36,7	▶ 06-418E-Ø
3-14,5	19,4	36,7	▶ 06-418E-Ø

## Sonstige Spannzangen, rund Collets, round

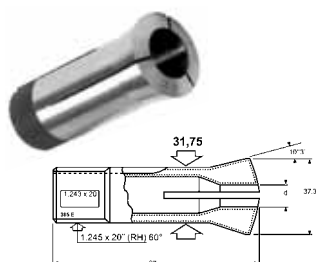

### Typ 385 E (5C), 0,5 mm steigend / 0,5 mm stepped

D mm	Art.-Nr. / Order no.
1 - 2,5 mm	● 06-385E-Ø
3 - 27 mm	● 06-385E-Ø
27,5 - 30 mm	● 06-385E-Ø

### Typ 369 E (R8), 1 mm steigend / 1 mm stepped

D mm	Art.-Nr. / Order no.
2 mm	● 06-369E-Ø
3 - 22 mm	● 06-369E-Ø

## Direktspannzangen Taper collets



### Mit Morsekegel With morse taper

MK / MT	Ø mm	Innengewinde / Internal thread	Art.-Nr. / Order no.
2	2, 3, 4, 5, 6, 8, 10, 12	M10	● 06-228-2-Ø
3	3, 4, 5, 6, 8, 10, 12, 14, 16, 18	M12	● 06-228-3-Ø
4	3, 4, 5, 6, 8, 10, 12, 14, 16, 18, 20, 22, 24, 25	M16	● 06-228-4-Ø



### Typ 574 E mit Steilkegel Type 574 E with steep taper

SK	Ø mm	Gewinde / Thread	Art.-Nr. / Order no.
40	4, 5, 6, 8, 10, 12, 14, 16, 18, 20, 22, 24, 25	S20 x 2	▶ 06-DSSK-S20-Ø



### Typ 575 E mit Steilkegel Type 575 E with steep taper

SK	Ø mm	Gewinde / Thread	Art.-Nr. / Order no.
40	4, 5, 6, 8, 10, 12, 14, 16, 18, 20, 22, 24, 25	M16	▶ 06-DSSK-M16-Ø

- Lagerstandard / in stock
- ▶ innerhalb weniger Tage / within a few days
- auf Anfrage / on request
- \* auslaufende Größe / as stock lasts

# Spannzangen DIN 6343 Collets DIN 6343

## Typ 161 E, 0,5 mm steigend / 0,5 mm stepped

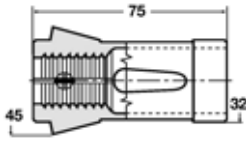

D mm	Form / form	Art.-Nr. / Order no.
3-26 mm	rund / round	06-161E-Ø

Bis Ø 7 mm - glatte Bohrung, ab Ø 8 mm mit Querrillen  
Up to Ø 7 mm - smooth bore, from Ø 8 mm - radial grooved

## Typ 163 E, 0,5 mm steigend / 0,5 mm stepped

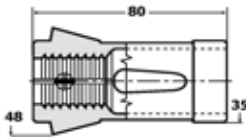

D mm	Form / form	Art.-Nr. / Order no.
3-30 mm	rund / round	06-163E-Ø

Bis Ø 7 mm - glatte Bohrung, ab Ø 8 mm mit Querrillen  
Up to Ø 7 mm - smooth bore, from Ø 8 mm - radial grooved

## Typ 173 E, 1 mm steigend / 1 mm stepped

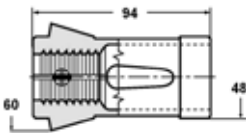

Größe / Size	Form / form	Art.-Nr. / Order no.
Ø 3 - 42 mm	rund / round	06-173E-Ø
□ 4 - 30 mm	vierkant / square	06-173E-Ø-4Kant
⬡ 4 - 36 mm	sechskant / hexagonal	06-173E-Ø-6Kant
Nofallspannzange / Emergency collet 173 E		06-173E-NOT

Bis Ø 7 mm - glatte Bohrung, ab Ø 8 mm mit Querrillen  
Up to Ø 7 mm - smooth bore, from Ø 8 mm - radial grooved

## Typ 185 E, 1 mm steigend / 1 mm stepped

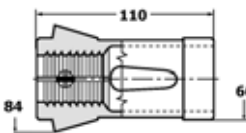

Größe / Size	Form / form	Art.-Nr. / Order no.
Ø 4 - 60 mm	rund / round	06-185E-Ø
□ 10 - 42 mm	vierkant / square	06-185E-Ø-4Kant
⬡ 6 - 52 mm	sechskant / hexagonal	06-185E-Ø-6Kant
Nofallspannzange / Emergency collet 185 E		06-185E-NOT

Bis Ø 7 mm - glatte Bohrung, ab Ø 8 mm mit Querrillen  
Up to Ø 7 mm - smooth bore, from Ø 8 mm - radial grooved

## Typ 193 E, 5 mm steigend / 5 mm stepped

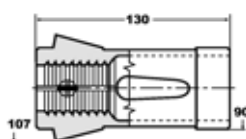

D mm	Form / form	Art.-Nr. / Order no.
20 - 80	rund / round	06-193E-Ø

Weitere Größen auf Anfrage  
Further sizes available upon request



# Spannköpfe Clamping heads



## Größe 42, rund, glatt Size 42, round, smooth

Spanndurchmesser / Clamping diameter mm	Steigung / Pitch mm	Art.-Nr. / Order no.
3 - 42	0,5	<input checked="" type="checkbox"/> 36-42RD-Ø



## Größe 42, rund, quengerillt Size 42, round, radial grooves

Spanndurchmesser / Clamping diameter mm	Steigung / Pitch mm	Art.-Nr. / Order no.
8 - 42	0,5	<input checked="" type="checkbox"/> 36-42RD-ØQ



## Größe 42, rund, längs- und quengerillt Size 42, round, radial and axial grooves

Spanndurchmesser / Clamping diameter mm	Steigung / Pitch mm	Art.-Nr. / Order no.
11 - 42	0,5	<input checked="" type="checkbox"/> 36-42RD-ØLQ

## Größe 42, sechskant, glatt Size 42, hexagonal, smooth

Spanndurchmesser / Clamping diameter mm	Steigung / Pitch mm	Art.-Nr. / Order no.
7 - 38	1	<input checked="" type="checkbox"/> 36-42SK-Ø

## Größe 42, sechskant, quengerillt Size 42, hexagonal, radial grooves

Spanndurchmesser / Clamping diameter mm	Steigung / Pitch mm	Art.-Nr. / Order no.
8 - 38	1	<input checked="" type="checkbox"/> 36-42SK-ØQ



# Spannköpfe Clamping heads



## Größe 65, rund, glatt Size 65, round, smooth

Spanndurchmesser / Clamping diameter mm	Steigung / Pitch mm	Art.-Nr. / Order no.
4 - 65	0,5	▶ 36-65RD-Ø



## Größe 65, rund, quengerillt Size 65, round, radial grooves

Spanndurchmesser / Clamping diameter mm	Steigung / Pitch mm	Art.-Nr. / Order no.
8 - 65	0,5	▶ 36-65RD-ØQ



## Größe 65, rund, längs- und quengerillt Size 65, round, radial and axial grooves

Spanndurchmesser / Clamping diameter mm	Steigung / Pitch mm	Art.-Nr. / Order no.
11 - 65	0,5	▶ 36-65RD-ØLQ

## Größe 65, sechskant, glatt Size 65, hexagonal, smooth

Spanndurchmesser / Clamping diameter mm	Steigung / Pitch mm	Art.-Nr. / Order no.
7 - 56	1	▶ 36-65SK-Ø

## Größe 65, sechskant, quengerillt Size 65, hexagonal, radial grooves

Spanndurchmesser / Clamping diameter mm	Steigung / Pitch mm	Art.-Nr. / Order no.
8 - 56	1	▶ 36-65SK-ØQ



# Spannzangen-Sätze, 1 mm steigend Collet sets, 1 mm stepped



## Spannzangen-Sätze ER in Holzleiste DIN 6499 Collet sets ER in wooden tray DIN 6499

Typ / Type	D mm	Anzahl d. Spannzangen / Number of collets	Art.-Nr. / Order no.
ER 11 (4008E)*	1-7	13	● 09-SATZ-ER11HL
ER 16 (426E)	1-10	10	● 09-SATZ-ER16HL
ER 20 (428E)	2-13	12	● 09-SATZ-ER20HL
ER 25 (430E)	2-16	15	● 09-SATZ-ER25HL
ER 32 (470E)	3-20	18	● 09-SATZ-ER32HL
ER 40 (472E)	4-26	23	● 09-SATZ-ER40HL

\* 0,5 mm steigend  
\* 0,5 mm stepped

## Spannzangen-Sätze ER im Aluminiumkoffer DIN 6499 Collet sets ER in aluminium case DIN 6499



Typ / Type	D mm	Anzahl d. Spannzangen / Number of collets	Art.-Nr. / Order no.
ER 16 (426E)	1-10	10	● 09-SATZ-ER16AK
ER 20 (428E)	2-13	12	● 09-SATZ-ER20AK
ER 25 (430E)	2-16	15	● 09-SATZ-ER25AK
ER 32 (470E)	3-20	18	● 09-SATZ-ER32AK
ER 40 (472E)	4-26	23	● 09-SATZ-ER40AK

## Präzisions-Spannzangen-Sätze ER in Holzleiste DIN 6499 Precision collet sets ER in wooden tray DIN 6499

- Präzisionsausführung

- precision type



Typ / Type	D mm	Anzahl d. Spannzangen / Number of collets	Art.-Nr. / Order no.
ER 11 (4008E)	1-7	7	● 09-SATZ-ER11-UP
ER 16 (426E)	1-10	10	● 09-SATZ-ER16-UP
ER 20 (428E)	2-13	12	● 09-SATZ-ER20-UP
ER 25 (430E)	2-16	15	● 09-SATZ-ER25-UP
ER 32 (470E)	3-20	18	● 09-SATZ-ER32-UP
ER 40 (472E)	4-26	23	● 09-SATZ-ER40-UP



## Abgedichtete Spannzangen-Sätze ER in Holzleiste DIN 6499 Sealed collet sets ER in wooden tray DIN 6499

- abgedichtete Ausführung

- sealed type



Typ / Type	D mm	Anzahl d. Spannzangen / Number of collets	Art.-Nr. / Order no.
ER 11 (4012E)	3-7	5	● 09-SATZ-ER11-SD
ER 16 (425E)	3-10	8	● 09-SATZ-ER16-SD
ER 20 (427E)	3-13	11	● 09-SATZ-ER20-SD
ER 25 (429E)	3-16	14	● 09-SATZ-ER25-SD
ER 32 (469E)	3-20	18	● 09-SATZ-ER32-SD
ER 40 (471E)	4-26	23	● 09-SATZ-ER40-SD

- Lagerstandard / in stock
- ▶ innerhalb weniger Tage / within a few days
- auf Anfrage / on request
- ✘ auslaufende Größe / as stock lasts



## Spannzangen-Sätze Collet sets



### Spannzangen-Sätze OZ in Holzleiste DIN 6388 Collet sets OZ in wooden tray DIN 6388

Typ / Type	D mm	Anzahl d. Spannzangen / Number of collets	Art.-Nr. / Order no.
415 E	2-16	15	06-SATZ-415EHL
462 E	2-25	24	06-SATZ-462EHL
467 E	4-32	29	06-SATZ-467EHL
410 E	2-16	15	06-SATZ-410EHL
444 E	2-25	24	06-SATZ-444EHL



### Spannzangen-Sätze OZ im Aluminiumkoffer DIN 6388 Collet sets OZ in aluminium case DIN 6388

Typ / Type	D mm	Anzahl d. Spannzangen / Number of collets	Art.-Nr. / Order no.
415 E	2-16	15	06-SATZ-415EAK
462 E	2-25	24	06-SATZ-462EAK
467 E	4-32	29	06-SATZ-467EAK
410 E	2-16	15	06-SATZ-410EAK
444 E	2-25	24	06-SATZ-444EAK



### Sonstige Spannzangen Sätze Optional collet sets

Typ / Type	D mm	Steigung / Stepping	Holzleiste / wooden tray	Anzahl d. Spannzangen / Number of collets	Art.-Nr. / Order no.
385 E	3-26	1	Ja / Yes	24	06-SATZ-385EHL
385 E	1-29	0,5	Nein / No	57	06-SATZ-385E/0,5
173 E	3-42	1	Nein / No	40	06-SATZ-173E
173 E	3-42	0,5	Nein / No	79	06-SATZ-173E/0,5

## Anschlagschrauben Stop screws



### Für 5C-Spannzangen For 5C-collets

- Gewinde auf ganzer Länge gehärtet
- für einstellbare Werkstücktiefen bis 75 mm (von Spannzangenoberfläche)
- thread hardened over entire length
- for adjustable work piece depths up to 75 mm (from collet surface)

Spannzange / Collet	Art.-Nr. / Order no.
für 5C-Spannzangen / for 5C-collets	06-106220

### Für Spannzangen DIN 6343 For collets DIN 6343

- für Spannzangen 163E, 173E, 185E
- for collets 163E, 173E, 185E

Spannzange / Collet	Art.-Nr. / Order no.
für 173E / for 173E	06-173E-AN
für 185E / for 185E	06-185E-AN



## Aluminiumkoffer Aluminium cases



### Für Spannzangen For collets

Passend für / Suitable for	Anzahl der Plätze / Number of seats	Art.-Nr. / Order no.
ER 16	10	● 09-ER16-AK
ER 20	13	● 09-ER20-AK
ER 25 / 410E / 415E	16	● 09-ER25/415E-AK
ER 32	20	● 09-ER32-AK
444E / 462E	25	● 09-462E-AK
ER 40 / 450E / 467E	30	● 09-ER40/467E-AK



### Für Spannzangen und Futter For collets and collet chucks

- geeignet für Spannzangensatz und Spannzangenfutter SK30 und SK40
- suitable for collet set and collet chucks SK30 and SK40

Passend für / Suitable for	Anzahl der Plätze / Number of seats	Art.-Nr. / Order no.
ER 25	16	● 09-ALK-ER25
ER 32	20	● 09-ALK-ER32
ER 40	24	● 09-ALK-ER40



### Für Kantentaster For edge finders

Passend für / Suitable for	Abmessungen / Dimensions mm	Art.-Nr. / Order no.
42-1010-N + 42-10104-N	140 x 56 x 42	● 42-1010-AK

**Kantentaster siehe Seite 275**  
**Edge finders see page 275**