



DELİK DELME ve İŞLEME TAKIMLARI
DRILLING and HOLEMAKING TOOLS
BOHRWERKZEUGE





*konusulan
the spoken kalite...
quality...*

U-DRILL

TAKMA UÇLU MATKAPLAR
U-DRILL SYSTEM
VOLLBOHRER

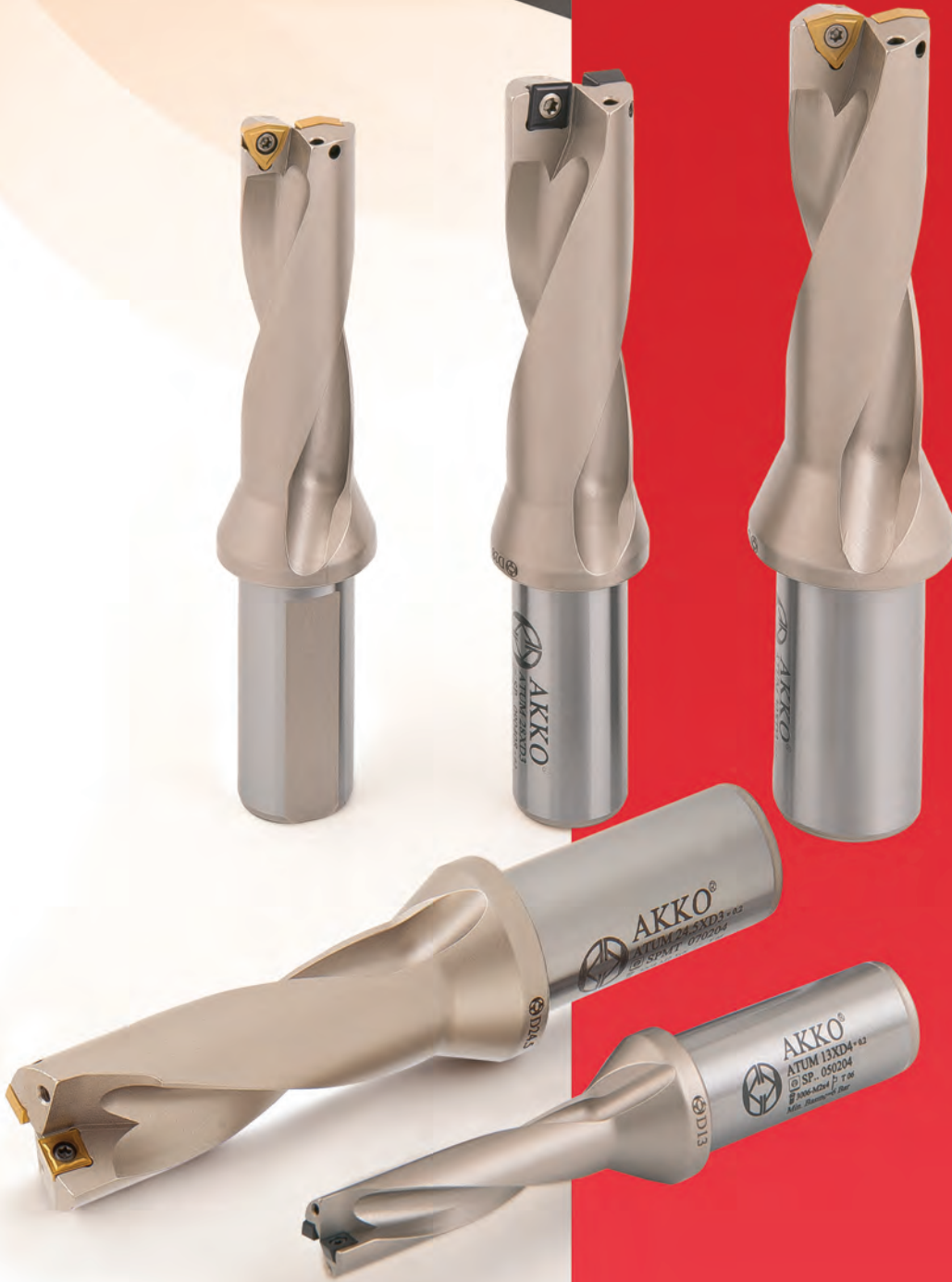



AKKO **A** **TUM** **16** x **D3**

S **P** **G** **T** **06** **02** **04**

2 Kesici Stili / Cutter Style
Werkzeugtyp

TUM: Takma Uçlu Matkap
U-Drill
Vollbohrer

3 Takım Çapı / Tool Diameter
Werkzeugdurchmesser

4 Delme Derinliği / Drilling Depth
Bohrtiefe

5 Uç Şekli / Insert Form
Plattenform

W **S**

6 Serbest Uç Açısı / Clearance angle of Insert
Freiwinkel der Wendschneidplatte

C **P**

8 Uç Tipi / Insert Type
Plattentyp

A J T
 $\beta = 70-90^\circ$ $\beta = 70-90^\circ$ $\beta = 40-60^\circ$

B M U
 $\beta = 70-90^\circ$ $\beta = 40-60^\circ$ $\beta = 40-60^\circ$

C N W
 $\beta = 70-90^\circ$ $\beta = 40-60^\circ$ $\beta = 40-60^\circ$

F Q X **Özel**
 $\beta = 70-90^\circ$ $\beta = 40-60^\circ$ **Special**

G R **Sonder**

H

10 Kalınlık / Thickness
Dicke

01 s = 1.59
T1 s = 1.98
02 s = 2.38
T2 s = 2.78
03 s = 3.18
T3 s = 3.97
04 s = 4.76
05 s = 5.56
06 s = 6.35
07 s = 7.94
09 s = 9.52

7 Toleranslar / Tolerance Classes
Toleranzen

	IC	M	S
A	± 0.025	± 0.005	± 0.025
C	± 0.025	± 0.013	± 0.025
E	± 0.025	± 0.025	± 0.025
F	± 0.013	± 0.005	± 0.025
G	± 0.025	± 0.025	± 0.130
H	± 0.013	± 0.013	± 0.025
J	± 0.05-0.15	± 0.005	± 0.025
K	± 0.05-0.15	± 0.013	± 0.025
L	± 0.05-0.15	± 0.025	± 0.025
M	± 0.05-0.15	± 0.08-0.20	± 0.130
N	± 0.05-0.15	± 0.08-0.20	± 0.025
U	± 0.08-0.25	± 0.13-0.38	± 0.130

IC : Daire Ölçüsü / Inscribed Circle / Kreisgröße
M : Şekle Göre / Refer to Figure / Siehe Abbildung
S : Kalınlık / Thickness / Dicke

9 Kesme Kenar Uzunluğu / Cutting Edge Length
Schneidkantenlänge

11 Köşe Konfigürasyonu / Corner Radius
Eckenradius

01 r = 0.1
02 r = 0.2
04 r = 0.4
08 r = 0.8
12 r = 1.2
16 r = 1.6
24 r = 2.4



Delme Derinliği
Drilling Depth
Bohrtiefe

= 2xÇap
= 2xDiameter
= 2xDurchmesser

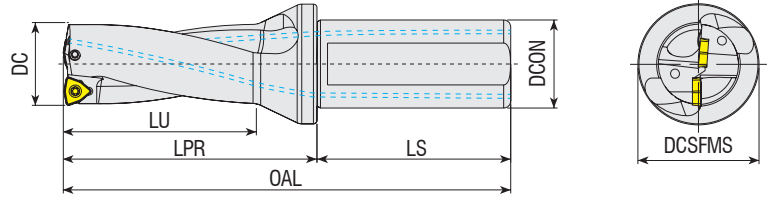

Takım Kodu
Ordering Code
Bestell-Bezeichnung

Stok
Stock
Lager

Takım Ölçüleri (mm)
Dimension (mm)
Abmessung (mm)

Maks. Ofset (radyal)
Max. Offset (radial)
Max. Versatz (radial)

Kesici Uç
Insert
Wendeschneidplatte

Yedek Parçaları / Spare Parts / Ersatzteile

Sıkma Vidası
Screw
Schraube

Tork Anahtar
Torx Key
Torx-Schlüssel

DC DCON DCFSMS OAL LU LPR LS

X_{max}
X_{max}[mm] DC_{max}[mm]

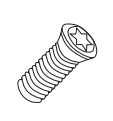

Takım Kodu Ordering Code Bestell-Bezeichnung	Stok Stock Lager	DC	DCON	DCFSMS	OAL	LU	LPR	LS	Maks. Ofset (radyal) Max. Offset (radial) Max. Versatz (radial)	Kesici Uç Insert Wendeschneidplatte	Sıkma Vidası Screw Schraube	Tork Anahtar Torx Key Torx-Schlüssel
ATUM 16XD2 WCM. 030208	●	16	25	34	110	32	54	56	1.5	19	WCM. 030208	3008-M2.5x6
ATUM 16.5XD2 WCM. 030208	●	16.5	25	34	110	32	54	56	1.5	19.5		
ATUM 17XD2 WCM. 030208	●	17	25	34	112	34	56	56	1.5	20		
ATUM 17.5XD2 WCM. 030208	●	17.5	25	34	112	34	56	56	1.5	20.5		
ATUM 18XD2 WCM. 030208	●	18	25	34	114	36	58	56	1.4	20.8		
ATUM 18.5XD2 WCM. 030208	●	18.5	25	34	114	36	58	56	1.3	21.1		
ATUM 19XD2 WCM. 030208	●	19	25	34	116	38	60	56	1.2	21.4		
ATUM 19.5XD2 WCM. 030208	●	19.5	25	34	116	38	60	56	1.2	21.9		
ATUM 20XD2 WCM. 040208	●	20	25	34	118	40	62	56	1.4	22.8	WCM. 040208	3008-M2.5x6
ATUM 20.5XD2 WCM. 040208	●	20.5	25	34	118	40	62	56	1.4	23.3		
ATUM 21XD2 WCM. 040208	●	21	25	34	120	42	64	56	1	23		
ATUM 21.5XD2 WCM. 040208	●	21.5	25	34	120	42	64	56	1	23.5		
ATUM 22XD2 WCM. 040208	●	22	25	34	122	44	66	56	0.9	23.8		
ATUM 22.5XD2 WCM. 040208	●	22.5	25	34	122	44	66	56	0.9	24.3		
ATUM 23XD2 WCM. 040208	●	23	25	34	124	46	68	56	0.8	24.6		
ATUM 23.5XD2 WCM. 040208	●	23.5	25	34	124	46	68	56	0.8	25.1		
ATUM 24XD2 WCM. 050308	●	24	25	34	126	48	70	56	1.4	26.8	WCM. 050308	3008-M3x8
ATUM 24.5XD2 WCM. 050308	●	24.5	25	34	126	48	70	56	1.4	27.3		
ATUM 25XD2 WCM. 050308	●	25	25	34	128	50	72	56	1.4	27.8		
ATUM 25.5XD2 WCM. 050308	●	25.5	25	34	128	50	72	56	1.4	28.3		
ATUM 26XD2 WCM. 050308	●	26	25	34	130	52	74	56	1.4	28.8		
ATUM 26.5XD2 WCM. 050308	●	26.5	25	34	130	52	74	56	1.4	29.3		
ATUM 27XD2 WCM. 050308	●	27	25	34	132	54	76	56	1.4	29.8		
ATUM 27.5XD2 WCM. 050308	●	27.5	25	34	132	54	76	56	1.4	30.3		
ATUM 28XD2 WCM. 050308	●	28	25	34	134	56	78	56	1.4	30.8		
ATUM 28.5XD2 WCM. 050308	●	28.5	25	34	134	56	78	56	1.4	31.3		
ATUM 29XD2 WCM. 050308	●	29	25	34	136	58	80	56	1.4	31.8		
ATUM 29.5XD2 WCM. 050308	●	29.5	25	34	136	58	80	56	1.4	32.3		

R: Sağ / Right / Rechts L: Sol/Left/Links

● Stokta / In Stock / Auf Lager ○ Stokta Yok / Non Stock Item / Kein Lagerartikel, Lieferzeit auf Anfrage
ISO Ucuna Uygundur. / Compatible with ISO Insert. / Kompatibel mit ISO Wendeplatten.

Sipariş Örneği/Ordering Example/Bestellbeispiel

1 ad./pcs./stück ATUM 16XD2 WCM. 030208

Takma Uçlu Matkap Kullanım Kılavuzu : S 365 / User's Guide For U-Drills : P 365

S.366 Bedienungsanleitung für Vollbohrer



Delme Derinliği
Drilling Depth
Bohrtiefe

= 2xÇap
= 2xDiameter
= 2xDurchmesser

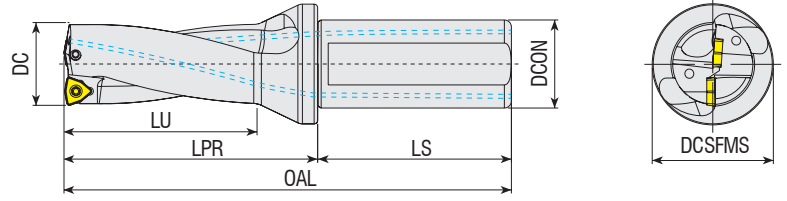

Takım Kodu
Ordering Code
Bestell-Bezeichnung

Stok Stock Lager	Takım Ölçüleri (mm) Dimension (mm) Abmessung (mm)								Maks. Ofset (radyal) Max. Offset (radial) Max. Versatz (radial)		Kesici Uç Insert Wendeschneidplatte	Yedek Parçaları / Spare Parts / Ersatzteile	
	DC	DCON	DCSFMS	OAL	LU	LPR	LS	X_{max}	DC_{max} [mm]	Sıkma Vidası Screw Schraube		Tork Anahtar Torx Key Torx-Schlüssel	
ATUM 30XD2 WCM. 06T308	30	32	44	147	60	87	60	2.4	34.8	WCM. 06T308	3010-M3.5x9	80-T10	
ATUM 31XD2 WCM. 06T308	31	32	44	149	62	89	60	2.3	35.6				
ATUM 32XD2 WCM. 06T308	32	32	44	151	64	91	60	2.1	36.2				
ATUM 33XD2 WCM. 06T308	33	32	44	153	66	93	60	1.9	36.8				
ATUM 34XD2 WCM. 06T308	34	32	44	155	68	95	60	1.9	37.8				
ATUM 35XD2 WCM. 06T308	35	32	44	157	70	97	60	1.8	38.6				
ATUM 36XD2 WCM. 06T308	36	32	44	159	72	99	60	1.7	39.4				
ATUM 37XD2 WCM. 06T308	37	32	44	161	74	101	60	1.6	40.2				
ATUM 38XD2 WCM. 06T308	38	32	44	163	76	103	60	1.5	41				
ATUM 39XD2 WCM. 06T308	39	32	44	165	78	105	60	1.3	41.6				
ATUM 40XD2 WCM. 06T308	40	32	44	167	80	107	60	1	42				
ATUM 41XD2 WCM. 06T308	41	32	44	169	82	109	60	0.8	42.6				
ATUM 42XD2 WCM. 06T308	42	32	44	171	84	111	60	0.5	43				
ATUM 43XD2 WCM. 06T308	43	32	44	173	86	113	60	0.3	43.6				
ATUM 44XD2 WCM. 06T308	44	32	44	175	88	115	60	0	44				
ATUM 45XD2 WCM. 080412	45	40	54	192	90	122	70	3.3	51.6	WCM. 080412	4015-M4x11	80-T15	
ATUM 46XD2 WCM. 080412	46	40	54	194	92	124	70	3	52				
ATUM 47XD2 WCM. 080412	47	40	54	196	94	126	70	2.8	52.6				
ATUM 48XD2 WCM. 080412	48	40	54	198	96	128	70	2.5	53				
ATUM 49XD2 WCM. 080412	49	40	54	200	98	130	70	2.2	53.4				
ATUM 50XD2 WCM. 080412	50	40	54	202	100	132	70	2	54				
ATUM 51XD2 WCM. 080412	51	40	54	204	102	134	70	1.8	54.6				
ATUM 52XD2 WCM. 080412	52	40	54	206	104	136	70	1.5	55				
ATUM 53XD2 WCM. 080412	53	40	54	208	106	138	70	1.3	55.6				
ATUM 54XD2 WCM. 080412	54	40	54	210	108	140	70	1	56				
ATUM 55XD2 WCM. 080412	55	40	54	212	110	142	70	0.8	56.6				
ATUM 56XD2 WCM. 080412	56	40	64	214	112	144	70	0.5	57				
ATUM 57XD2 WCM. 080412	57	40	64	216	114	146	70	0.3	57.6				
ATUM 58XD2 WCM. 080412	58	40	64	218	116	148	70	0	58				
ATUM 59XD2 WCM. 080412	59	40	64	220	118	150	70	0	59				
ATUM 60XD2 WCM. 080412	60	40	64	222	120	152	70	0	60				

R: Sağ / Right / Rechts L: Sol/Left/Links

● Stokta / In Stock / Auf Lager ○ Stokta Yok / Non Stock Item / Kein Lagerartikel, Lieferzeit auf Anfrage
ISO Ucuna Uygunudur. / Compatible with ISO Insert. / Kompatibel mit ISO Wendeplatten.

Sipariş Örneği/Ordering Example/Bestellbeispiel

1 ad./pcs./stück ATUM 30XD2 WCM. 06T308

Takma Uçlu Matkap Kullanım Kılavuzu : S 367 / User's Guide For U-Drills : P 367 / S.368 / Bedienungsanleitung für Vollbohrer



Delme Derinliği
Drilling Depth
Bohrtiefe

= 3xÇap
= 3xDiameter
= 3xDurchmesser

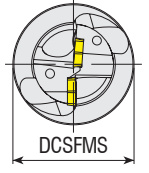
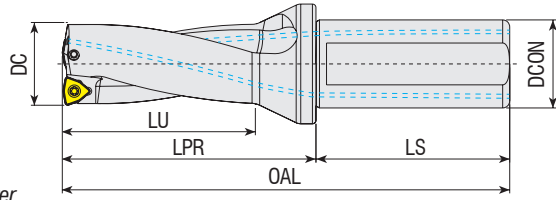

Takım Kodu Ordering Code Bestell-Bezeichnung	Stok Stock Lager	Takım Ölçüleri (mm) Dimension (mm) Abmessung (mm)							Maks. Ofset (radyal) Max. Offset (radial) Max. Versatz (radial)		Kesici Uç Insert Wendeschneidplatte	Sıkma Vidası Screw Schraube	Tork Anahtar Torx Key Torx-Schlüssel
		DC	DCON	DCSFMS	OAL	LU	LPR	LS	X _{max} X _{max} [mm]	DC _{max} DC _{max} [mm]			
ATUM 16XD3 WCM. 030208	●	16	25	34	126	48	70	56	1.5	19	WCM. 030208	3008-M2.5x6	80-T08
ATUM 16.5XD3 WCM. 030208	●	16.5	25	34	126	48	70	56	1.5	19.5			
ATUM 17XD3 WCM. 030208	●	17	25	34	129	51	73	56	1.5	20			
ATUM 17.5XD3 WCM. 030208	●	17.5	25	34	129	51	73	56	1.5	20.5			
ATUM 18XD3 WCM. 030208	●	18	25	34	132	54	76	56	1.4	20.8			
ATUM 18.5XD3 WCM. 030208	●	18.5	25	34	132	54	76	56	1.3	21.1			
ATUM 19XD3 WCM. 030208	●	19	25	34	135	57	79	56	1.2	21.4			
ATUM 19.5XD3 WCM. 030208	●	19.5	25	34	135	57	79	56	1.2	21.9			
ATUM 20XD3 WCM. 040208	●	20	25	34	138	60	82	56	1.4	22.8			
ATUM 20.5XD3 WCM. 040208	●	20.5	25	34	138	60	82	56	1.4	23.3			
ATUM 21XD3 WCM. 040208	●	21	25	34	141	63	85	56	1	23	WCM. 040208	3008-M2.5x6	80-T08
ATUM 21.5XD3 WCM. 040208	●	21.5	25	34	141	63	85	56	1	23.5			
ATUM 22XD3 WCM. 040208	●	22	25	34	144	66	88	56	0.9	23.8			
ATUM 22.5XD3 WCM. 040208	●	22.5	25	34	144	66	88	56	0.9	24.3			
ATUM 23XD3 WCM. 040208	●	23	25	34	147	69	91	56	0.8	24.6			
ATUM 23.5XD3 WCM. 040208	●	23.5	25	34	147	69	91	56	0.8	25.1			
ATUM 24XD3 WCM. 050308	●	24	25	34	150	72	94	56	1.4	26.8			
ATUM 24.5XD3 WCM. 050308	●	24.5	25	34	150	72	94	56	1.4	27.3			
ATUM 25XD3 WCM. 050308	●	25	25	34	153	75	97	56	1.4	27.8			
ATUM 25.5XD3 WCM. 050308	●	25.5	25	34	153	75	97	56	1.4	28.3			
ATUM 26XD3 WCM. 050308	●	26	25	34	156	78	100	56	1.4	28.8			
ATUM 26.5XD3 WCM. 050308	●	26.5	25	34	156	78	100	56	1.4	29.3			
ATUM 27XD3 WCM. 050308	●	27	25	34	159	81	103	56	1.4	29.8			
ATUM 27.5XD3 WCM. 050308	●	27.5	25	34	159	81	103	56	1.4	30.3			
ATUM 28XD3 WCM. 050308	●	28	25	34	162	84	106	56	1.4	30.8			
ATUM 28.5XD3 WCM. 050308	●	28.5	25	34	162	84	106	56	1.4	31.3			
ATUM 29XD3 WCM. 050308	●	29	25	34	165	87	109	56	1.4	31.8			
ATUM 29.5XD3 WCM. 050308	●	29.5	25	34	165	87	109	56	1.4	32.3			
ATUM 30XD3 WCM. 06T308	●	30	32	44	177	90	117	60	2.4	34.8	WCM. 06T308	3010-M3.5x9	80-T10
ATUM 30.5XD3 WCM. 06T308	●	30.5	32	44	177	90	117	60	2.4	35.3			
ATUM 31XD3 WCM. 06T308	●	31	32	44	180	93	120	60	2.3	35.6			
ATUM 31.5XD3 WCM. 06T308	●	31.5	32	44	180	93	120	60	2.3	36.1			
ATUM 32XD3 WCM. 06T308	●	32	32	44	183	96	123	60	2.1	36.2			
ATUM 32.5XD3 WCM. 06T308	●	32.5	32	44	183	96	123	60	2.1	36.7			
ATUM 33XD3 WCM. 06T308	●	33	32	44	186	99	126	60	1.9	36.8			
ATUM 33.5XD3 WCM. 06T308	●	33.5	32	44	186	99	126	60	1.9	37.3			
ATUM 34XD3 WCM. 06T308	●	34	32	44	189	102	129	60	1.9	37.8			
ATUM 34.5XD3 WCM. 06T308	●	34.5	32	44	189	102	129	60	1.9	38.3			

R: Sağ / Right / Rechts L: Sol/Left/Links

● Stokta / In Stock / Auf Lager ○ Stokta Yok / Non Stock Item / Kein Lagerartikel, Lieferzeit auf Anfrage

ISO Ucuca Uygunudur. / Compatible with ISO Insert. / Kompatibel mit ISO Wendepalten.

Sipariş Örneği/Ordering Example/Bestellbeispiel

1 ad./pcs./stück ATUM 16XD3 WCM. 030208

Takma Uçlu Matkap Kullanım Kılavuzu : S 367 / User's Guide For U-Drills : P 367

S.368 / Bedienungsanleitung für Vollbohrer



Delme Derinliği
Drilling Depth
Bohrtiefe

= 3xÇap
= 3xDiameter
= 3xDurchmesser

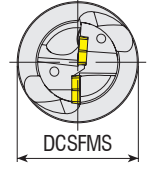
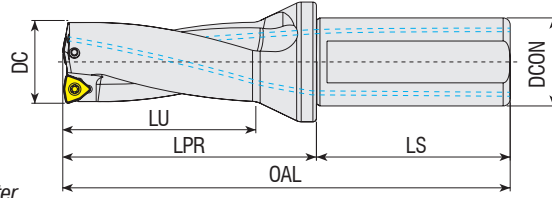

Takım Kodu
Ordering Code
Bestell-Bezeichnung

Stok
Stock
Lager

Takım Ölçüleri (mm)
Dimension (mm)
Abmessung (mm)

Maks. Ofset (radyal)
Max. Offset (radial)
Max. Versatz (radial)

Kesici Uç
Insert
Wendeschneidplatte

Yedek Parçaları / Spare Parts / Ersatzteile

Sıkma Vidası
Screw
Schraube

Tork Anahtar
Torx Key
Torx-Schlüssel

DC DCON DCSFMS OAL LU LPR LS

X_{max}
 $X_{max}[mm]$ $DC_{max}[mm]$



ATUM 35XD3 WCM. 06T308	●	35	32	44	192	105	132	60	1.8	38.6	WCM. 06T308	3010-M3.5x9	80-T10
ATUM 35.5XD3 WCM. 06T308	●	35.5	32	44	192	105	132	60	1.8	39.1			
ATUM 36XD3 WCM. 06T308	●	36	32	44	195	108	135	60	1.7	39.4			
ATUM 36.5XD3 WCM. 06T308	●	36.5	32	44	195	108	135	60	2	40.5			
ATUM 37XD3 WCM. 06T308	●	37	32	44	198	111	138	60	1.6	40.2			
ATUM 37.5XD3 WCM. 06T308	●	37.5	32	44	198	111	138	60	1.8	41.1			
ATUM 38XD3 WCM. 06T308	●	38	32	44	201	114	141	60	1.5	41			
ATUM 38.5XD3 WCM. 06T308	●	38.5	32	44	201	114	141	60	1.5	41.5			
ATUM 39XD3 WCM. 06T308	●	39	32	44	204	117	144	60	1.3	41.6			
ATUM 39.5XD3 WCM. 06T308	●	39.5	32	44	204	117	144	60	1.3	42.1			
ATUM 40XD3 WCM. 06T308	●	40	32	44	207	120	147	60	1	42			
ATUM 40.5XD3 WCM. 06T308	●	40.5	32	44	207	120	147	60	1	42.5			
ATUM 41XD3 WCM. 06T308	●	41	32	44	210	123	150	60	0.8	42.6			
ATUM 41.5XD3 WCM. 06T308	●	41.5	32	44	210	123	150	60	0.8	43.1			
ATUM 42XD3 WCM. 06T308	●	42	32	44	213	126	153	60	0.5	43			
ATUM 42.5XD3 WCM. 06T308	●	42.5	32	44	213	126	153	60	0.5	43.5			
ATUM 43XD3 WCM. 06T308	●	43	32	44	216	129	156	60	0.3	43.6			
ATUM 43.5XD3 WCM. 06T308	●	43.5	32	44	216	129	156	60	0.3	44.1			
ATUM 44XD3 WCM. 06T308	●	44	32	44	219	132	159	60	0	44			
ATUM 44.5XD3 WCM. 06T308	●	44.5	32	44	219	132	159	60	0	44.5			
ATUM 45XD3 WCM. 080412	●	45	40	54	237	135	167	70	3.3	51.6	WCM. 080412	4015-M4x11	80-T15
ATUM 45.5XD3 WCM. 080412	●	45.5	40	54	237	135	167	70	3.3	52.1			
ATUM 46XD3 WCM. 080412	●	46	40	54	240	138	170	70	3	52			
ATUM 47XD3 WCM. 080412	●	47	40	54	243	141	173	70	2.8	52.6			
ATUM 48XD3 WCM. 080412	●	48	40	54	246	144	176	70	2.5	53			
ATUM 49XD3 WCM. 080412	●	49	40	54	249	147	179	70	2.2	53.4			
ATUM 50XD3 WCM. 080412	●	50	40	54	252	150	182	70	2	54			
ATUM 51XD3 WCM. 080412	●	51	40	54	255	153	185	70	1.8	54.6			
ATUM 52XD3 WCM. 080412	●	52	40	54	258	156	188	70	1.5	55			
ATUM 53XD3 WCM. 080412	●	53	40	54	261	159	191	70	1.3	55.6			
ATUM 54XD3 WCM. 080412	●	54	40	54	264	162	194	70	1	56			
ATUM 55XD3 WCM. 080412	●	55	40	54	267	165	197	70	0.8	56.6			
ATUM 56XD3 WCM. 080412	●	56	40	64	270	168	200	70	0.5	57			
ATUM 57XD3 WCM. 080412	●	57	40	64	273	171	203	70	0.3	57.6			
ATUM 58XD3 WCM. 080412	●	58	40	64	276	174	206	70	0	58			
ATUM 59XD3 WCM. 080412	●	59	40	64	279	177	209	70	0	59			
ATUM 60XD3 WCM. 080412	●	60	40	64	282	180	212	70	0	60			

R: Sağ / Right / Rechts L: Sol/Left/Links

● Stokta / In Stock / Auf Lager ○ Stokta Yok / Non Stock Item / Kein Lagerartikel, Lieferzeit auf Anfrage

ISO Ucuna Uygunudur. / Compatiple with ISO Insert. / Kompatibel mit ISO Wendepplatten.

Sipariş Örneği/Ordering Example/Bestellbeispiel

1 ad./pcs./stück ATUM 35XD3 WCM. 06T308

Takma Uçlu Matkap Kullanım Kılavuzu : S 367 / User's Guide For U-Drills : P 367

S.368 / Bedienungsanleitung für Vollbohrer



Delme Derinliği
Drilling Depth
Bohrtiefe
= 4xÇap
= 4xDiameter
= 4xDurchmesser

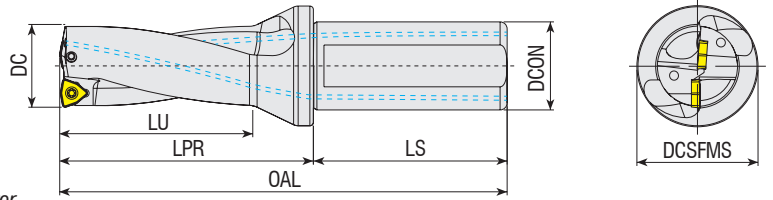

Takım Kodu Ordering Code Bestell-Bezeichnung	Stok Stock Lager	Takım Ölçüleri (mm) Dimension (mm) Abmessung (mm)							Maks. Ofset (radyal) Max. Offset (radial) Max. Versatz (radial)		Kesici Uç Insert Wendeschneidplatte	Yedek Parçaları / Spare Parts / Ersatzteile	
		DC	DCON	DCSFMS	OAL	LU	LPR	LS	X_{max}	DC_{max}		Sıkma Vidası Screw Schraube	Tork Anahtar Torx Key Torx-Schlüssel
ATUM 16XD4 WCM. 030208	●	16	25	34	142	64	86	56	1.5	19	WCM. 030208		
ATUM 16.5XD4 WCM. 030208	○	16.5	25	34	142	64	86	56	1.5	19.5			
ATUM 17XD4 WCM. 030208	●	17	25	34	146	68	90	56	1.5	20			
ATUM 17.5XD4 WCM. 030208	●	17.5	25	34	146	68	90	56	1.5	20.5			
ATUM 18XD4 WCM. 030208	●	18	25	34	150	72	94	56	1.4	20.8			
ATUM 18.5XD4 WCM. 030208	○	18.5	25	34	150	72	94	56	1.3	21.1			
ATUM 19XD4 WCM. 030208	●	19	25	34	154	76	98	56	1.2	21.4			
ATUM 19.5XD4 WCM. 030208	○	19.5	25	34	154	76	98	56	1.2	21.9			
ATUM 20XD4 WCM. 040208	●	20	25	34	158	80	102	56	1.4	22.8	WCM. 040208	3008-M2.5x6	80-T08
ATUM 20.5XD4 WCM. 040208	○	20.5	25	34	158	80	102	56	1.4	23.3			
ATUM 21XD4 WCM. 040208	●	21	25	34	162	84	106	56	1	23			
ATUM 21.5XD4 WCM. 040208	○	21.5	25	34	162	84	106	56	1	23.5			
ATUM 22XD4 WCM. 040208	●	22	25	34	166	88	110	56	0.9	23.8			
ATUM 22.5XD4 WCM. 040208	●	22.5	25	34	166	88	110	56	0.9	24.3			
ATUM 23XD4 WCM. 040208	●	23	25	34	170	92	114	56	0.8	24.6			
ATUM 23.5XD4 WCM. 040208	○	23.5	25	34	170	92	114	56	0.8	25.1			
ATUM 24XD4 WCM. 050308	●	24	25	34	174	96	118	56	1.4	26.8	WCM. 050308	3008-M3x8	
ATUM 24.5XD4 WCM. 050308	○	24.5	25	34	174	96	118	56	1.4	27.3			
ATUM 25XD4 WCM. 050308	●	25	25	34	178	100	122	56	1.4	27.8			
ATUM 25.5XD4 WCM. 050308	○	25.5	25	34	178	100	122	56	1.4	28.3			
ATUM 26XD4 WCM. 050308	●	26	25	34	182	104	126	56	1.4	28.8			
ATUM 26.5XD4 WCM. 050308	●	26.5	25	34	182	104	126	56	1.4	29.3			
ATUM 27XD4 WCM. 050308	●	27	25	34	186	108	130	56	1.4	29.8			
ATUM 27.5XD4 WCM. 050308	○	27.5	25	34	186	108	130	56	1.4	30.3			
ATUM 28XD4 WCM. 050308	●	28	25	34	190	112	134	56	1.4	30.8			
ATUM 28.5XD4 WCM. 050308	●	28.5	25	34	190	112	134	56	1.4	31.3			
ATUM 29XD4 WCM. 050308	●	29	25	34	194	116	138	56	1.4	31.8			
ATUM 29.5XD4 WCM. 050308	○	29.5	25	34	194	116	138	56	1.4	32.3			

R: Sağ / Right / Rechts L: Sol/Left/Links
● Stokta / In Stock / Auf Lager ○ Stokta Yok / Non Stock Item / Kein Lagerartikel, Lieferzeit auf Anfrage
ISO Ucuna Uygunudur. / Compatible with ISO Insert. / Kompatibel mit ISO Wendeplatten.

Sipariş Örneği/Ordering Example/Bestellbeispiel
1 ad./pcs./stück ATUM 16XD4 WCM. 030208

Takma Uçlu Matkap Kullanım Kılavuzu : S 367 / User's Guide For U-Drills : P 367
S.368 / Bedienungsanleitung für Vollbohrer



Delme Derinliği
Drilling Depth
Bohrtiefe
= 4xÇap
= 4xDiameter
= 4xDurchmesser

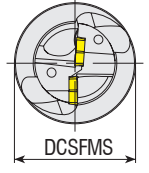
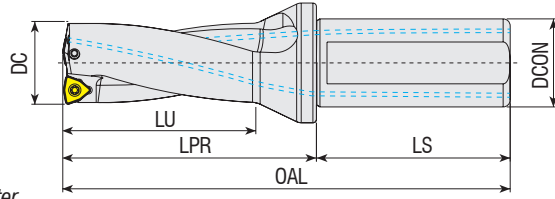

Takım Kodu
Ordering Code
Bestell-Bezeichnung

Stok
Stock
Lager

Takım Ölçüleri (mm)
Dimension (mm)
Abmessung (mm)

Maks. Ofset (radyal)
Max. Offset (radial)
Max. Versatz (radial)

Kesici Uç
Insert
Wendeschneidplatte

Yedek Parçaları / Spare Parts / Ersatzteile

Sıkma Vidası
Screw
Schraube

Tork Anahtar
Torx Key
Torx-Schlüssel

DC	DCON	DCSFMS	OAL	LU	LPR	LS
----	------	--------	-----	----	-----	----

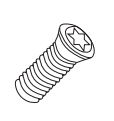
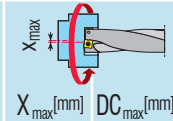

Takım Kodu	Stok	DC	DCON	DCSFMS	OAL	LU	LPR	LS	Maks. Ofset	DC_max	Kesici Uç	Sıkma Vidası	Tork Anahtar
ATUM 30XD4 WCM. 06T308	●	30	32	44	207	120	147	60	2.4	34.8	WCM. 06T308	3010-M3.5x9	80-T10
ATUM 31XD4 WCM. 06T308	●	31	32	44	211	124	151	60	2.3	35.6			
ATUM 32XD4 WCM. 06T308	●	32	32	44	215	128	155	60	2.1	36.2			
ATUM 33XD4 WCM. 06T308	●	33	32	44	219	132	159	60	1.9	36.8			
ATUM 33.5XD4 WCM. 06T308	●	33.5	32	44	219	132	159	60	1.9	37.3			
ATUM 34XD4 WCM. 06T308	●	34	32	44	223	136	163	60	1.9	37.8			
ATUM 35XD4 WCM. 06T308	●	35	32	44	227	140	167	60	1.8	38.6			
ATUM 36XD4 WCM. 06T308	●	36	32	44	231	144	171	60	1.7	39.4			
ATUM 37XD4 WCM. 06T308	●	37	32	44	235	148	175	60	1.6	40.2			
ATUM 38XD4 WCM. 06T308	●	38	32	44	239	152	179	60	1.5	41			
ATUM 38.5XD4 WCM. 06T308	●	38.5	32	44	239	152	179	60	1.5	41.5			
ATUM 39XD4 WCM. 06T308	●	39	32	44	243	156	183	60	1.3	41.6			
ATUM 40XD4 WCM. 06T308	●	40	32	44	247	160	187	60	1	42			
ATUM 41XD4 WCM. 06T308	●	41	32	44	251	164	191	60	0.8	42.6			
ATUM 42XD4 WCM. 06T308	●	42	32	44	255	168	195	60	0.5	43			
ATUM 43XD4 WCM. 06T308	●	43	32	44	259	172	199	60	0.3	43.6			
ATUM 44XD4 WCM. 06T308	●	44	32	44	263	176	203	60	0	44			
ATUM 45XD4 WCM. 080412	●	45	40	54	282	180	212	70	3.3	51.6	WCM. 080412	4015-M4x11	80-T15
ATUM 46XD4 WCM. 080412	●	46	40	54	286	184	216	70	3	52			
ATUM 47XD4 WCM. 080412	●	47	40	54	290	188	220	70	2.8	52.6			
ATUM 48XD4 WCM. 080412	●	48	40	54	294	192	224	70	2.5	53			
ATUM 49XD4 WCM. 080412	●	49	40	54	298	196	228	70	2.2	53.4			
ATUM 50XD4 WCM. 080412	●	50	40	54	302	200	232	70	2	54			

R: Sağ / Right / Rechts L: Sol/Left/Links

● Stokta / In Stock / Auf Lager ○ Stokta Yok / Non Stock Item / Kein Lagerartikel, Lieferzeit auf Anfrage
ISO Ucuna Uygundur. / Compatible with ISO Insert. / Kompatibel mit ISO Wendeplatten.

Sipariş Örneği/Ordering Example/Bestellbeispiel
1 ad./pcs./stück ATUM 30XD4 WCM. 06T308

Takma Uçlu Matkap Kullanım Kılavuzu : S 367 / User's Guide For U-Drills : P 367
S.368 / Bedienungsanleitung für Vollbohrer



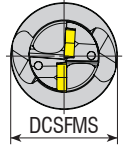
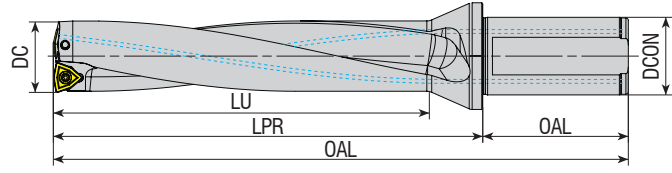

Delme Derinliği
Drilling Depth
Bohrtiefe
= 5xÇap
= 5xDiameter
= 5xDurchmesser

Takım Kodu Ordering Code Bestell-Bezeichnung	Stok Stock Lager	Takım Ölçüleri (mm) Dimension (mm) Abmessung (mm)							Maks. Ofset (radyal) Max. Offset (radial) Max. Versatz (radial)	Kesici Uç Insert Wendeschneidplatte	Yedek Parçaları / Spare Parts / Ersatzteile		
		DC	DCON	DCSFMS	OAL	LU	LPR	LS			Sıkma Vidası Screw Schraube	Tork Anahtar Torx Key Torx-Schlüssel	
ATUM 20XD5 WCM. 040208	●	20	25	34	178	100	122	56	1.4	22.8	WCM. 040208	3008-M2.5x6	80-T08
ATUM 21XD5 WCM. 040208	●	21	25	34	183	105	127	56	1	23			
ATUM 22XD5 WCM. 040208	●	22	25	34	188	110	132	56	0.9	23.8			
ATUM 23XD5 WCM. 040208	●	23	25	34	193	115	137	56	0.8	24.6			
ATUM 24XD5 WCM. 050308	●	24	25	34	198	120	142	56	1.4	26.8	WCM. 050308	3008-M3x8	80-T08
ATUM 25XD5 WCM. 050308	●	25	25	34	203	125	147	56	1.4	27.8			
ATUM 26XD5 WCM. 050308	●	26	25	34	208	130	152	56	1.4	28.8			
ATUM 27XD5 WCM. 050308	●	27	25	34	213	135	157	56	1.4	29.8			
ATUM 28XD5 WCM. 050308	●	28	25	34	218	140	162	56	1.4	30.8			
ATUM 29XD5 WCM. 050308	●	29	25	34	223	145	167	56	1.4	31.8			
ATUM 30XD5 WCM. 06T308	●	30	32	44	237	150	177	60	2.4	34.8	WCM. 06T308	3010-M3.5x9	80-T10
ATUM 31XD5 WCM. 06T308	●	31	32	44	242	155	182	60	2.3	35.6			
ATUM 32XD5 WCM. 06T308	●	32	32	44	247	160	187	60	2.1	36.2			
ATUM 33XD5 WCM. 06T308	●	33	32	44	252	165	192	60	1.9	36.8			
ATUM 34XD5 WCM. 06T308	●	34	32	44	257	170	197	60	1.9	37.8			
ATUM 35XD5 WCM. 06T308	●	35	32	44	262	175	202	60	1.8	38.6			
ATUM 37XD5 WCM. 06T308	●	37	32	44	272	185	212	60	1.6	40.2			
ATUM 38XD5 WCM. 06T308	●	38	32	44	277	190	217	60	1.5	41			
ATUM 46XD5 WCM. 080412	●	46	40	54	332	230	262	70	3	52	WCM. 080412	4015-M4x11	80-T15

R: Sağ / Right / Rechts L: Sol/Left/Links
● Stokta / In Stock / Auf Lager ○ Stokta Yok / Non Stock Item / Kein Lagerartikel, Lieferzeit auf Anfrage
ISO Ucuna Uygun. / Compatible with ISO Insert. / Kompatibel mit ISO Wendepplatten.

Sipariş Örneği/Ordering Example/Bestellbeispiel
1 ad./pcs./stück ATUM 20XD5 WCM. 040208

Takma Uçlu Matkap Kullanım Kılavuzu : S 367 / User's Guide For U-Drills : P 367
S.368 / Bedienungsanleitung für Vollbohrer



Delme Derinliği
Drilling Depth
Bohrtiefe

= 2xÇap
= 2xDiameter
= 2xDurchmesser

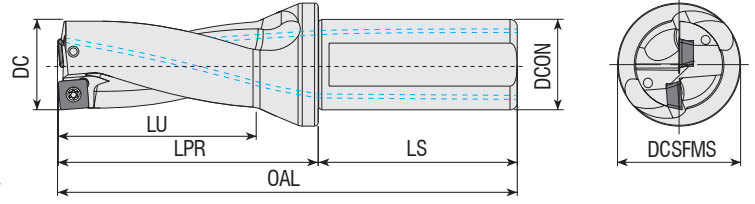

Takım Kodu
Ordering Code
Bestell-Bezeichnung

Stok
Stock
Lager

Takım Ölçüleri (mm)
Dimension (mm)
Abmessung (mm)

Maks. Ofset (radyal)
Max. Offset (radial)
Max. Versatz (radial)

Kesici Uç
Insert
Wendeschneidplatte

Yedek Parçaları / Spare Parts / Ersatzteile

Sıkma Vidası
Screw
Schraube

Tork Anahtar
Torx Key
Torx-Schlüssel

Takım Kodu Ordering Code Bestell-Bezeichnung	Stok Stock Lager	Takım Ölçüleri (mm) Dimension (mm) Abmessung (mm)							Maks. Ofset (radyal) Max. Offset (radial) Max. Versatz (radial)		Kesici Uç Insert Wendeschneidplatte	Sıkma Vidası Screw Schraube	Tork Anahtar Torx Key Torx-Schlüssel
		DC	DCON	DCSFMS	OAL	LU	LPR	LS	X _{max}	DC _{max}			
ATUM 12.5XD2 SP.. 050204	●	12.5	20	25	96	24	46	50	0.5	13.5	SP.. 050204	3006-M2x4	80-T06
ATUM 13XD2 SP.. 050204	●	13	20	25	98	26	48	50	0.5	14			
ATUM 13.5XD2 SP.. 050204	●	13.5	20	25	98	26	48	50	0.5	14.5			
ATUM 14XD2 SP.. 050204	●	14	20	25	100	28	50	50	0.5	15			
ATUM 14.5XD2 SP.. 050204	●	14.5	20	25	100	28	50	50	0.5	15.5			
ATUM 15XD2 SP.. 050204	●	15	20	25	102	30	52	50	0.5	16			
ATUM 15.5XD2 SP.. 060204	●	15.5	20	25	102	30	52	50	0.5	16.5	SP.. 060204	3007-M2.2x5	80-T07
ATUM 16XD2 SP.. 060204	●	16	25	34	110	32	54	56	0.5	17			
ATUM 16.5XD2 SP.. 060204	●	16.5	25	34	110	32	54	56	0.5	17.5			
ATUM 17XD2 SP.. 060204	●	17	25	34	112	34	56	56	0.5	18			
ATUM 17.5XD2 SP.. 060204	●	17.5	25	34	112	34	56	56	0.5	18.5			
ATUM 18XD2 SP.. 060204	●	18	25	34	114	36	58	56	0.5	19			
ATUM 18.5XD2 SP.. 060204	●	18.5	25	34	114	36	58	56	0.5	19.5			
ATUM 19XD2 SP.. 060204	●	19	25	34	116	38	60	56	0.25	19.5			
ATUM 19.5XD2 SP.. 060204	●	19.5	25	34	116	38	60	56	0.25	20			
ATUM 20XD2 SP.. 060204	●	20	25	34	118	40	62	56	0	20			
ATUM 20.5XD2 SP.. 060204	●	20.5	25	34	118	40	62	56	0	20.5			
ATUM 21XD2 SP.. 060204	●	21	25	34	120	42	64	56	0	21			
ATUM 21.5XD2 SP.. 060204	●	21.5	25	34	120	42	64	56	0	21.5			
ATUM 22XD2 SP.. 07T308	●	22	25	34	122	44	66	56	0.5	23			
ATUM 22.5XD2 SP.. 07T308	●	22.5	25	34	122	44	66	56	0.5	23.5			
ATUM 23XD2 SP.. 07T308	●	23	25	34	124	46	68	56	0.5	24			
ATUM 23.5XD2 SP.. 07T308	●	23.5	25	34	124	46	68	56	0.5	24.5			
ATUM 24XD2 SP.. 07T308	●	24	25	34	126	48	70	56	0.5	25			
ATUM 24.5XD2 SP.. 07T308	●	24.5	25	34	126	48	70	56	0.5	25.5			
ATUM 25XD2 SP.. 07T308	●	25	25	34	128	50	72	56	0.25	25.5			
ATUM 25.5XD2 SP.. 07T308	●	25.5	25	34	128	50	72	56	0.25	26			
ATUM 26XD2 SP.. 07T308	●	26	25	34	130	52	74	56	0	26			
ATUM 26.5XD2 SP.. 07T308	●	26.5	25	34	130	52	74	56	0	26.5			
ATUM 27XD2 SP.. 07T308	●	27	25	34	132	54	76	56	0	27			
ATUM 27.5XD2 SP.. 07T308	●	27.5	25	34	132	54	76	56	0	27.5			

R: Sağ / Right / Rechts L: Sol/Left/Links
● Stokta / In Stock / Auf Lager ○ Stokta Yok / Non Stock Item / Kein Lagerartikel, Lieferzeit auf Anfrage
TGTC Ucuna Uygunudur. / Compatiple with TGTC Insert. / Kompatibel mit TGTC Wendepplatten.

Sipariş Örneği/Ordering Example/Bestellbeispiel
1 ad./pcs./stück ATUM 12.5XD2 SP.. 050204

Takma Uçlu Matkap Kullanım Kılavuzu : S 367 / User's Guide For U-Drills : P 367
S.368 / Bedienungsanleitung für Vollbohrer



Delme Derinliği
Drilling Depth
Bohrtiefe
= 2xÇap
= 2xDiameter
= 2xDurchmesser

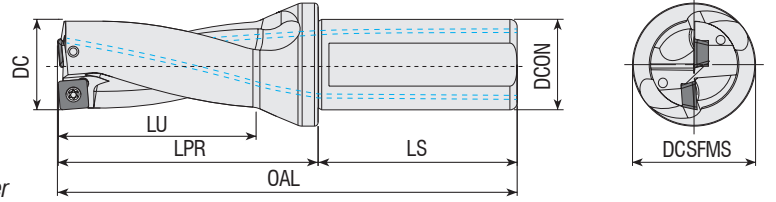

Takım Kodu Ordering Code Bestell-Bezeichnung	Stok Stock Lager	Takım Ölçüleri (mm) Dimension (mm) Abmessung (mm)							Maks. Ofset (radyal) Max. Offset (radial) Max. Versatz (radial)		Kesici Uç Insert Wendeschneidplatte	Yedek Parçaları / Spare Parts / Ersatzteile	
		DC	DCON	DCSFMS	OAL	LU	LPR	LS	X _{max}	DC _{max}		Sıkma Vidası Screw Schraube	Tork Anahtar Torx Key Torx-Schlüssel
ATUM 28XD2 SP. 090408	●	28	25	34	134	56	78	56	0.5	29	SP. 090408	4015-M3.5x9	80-T15
ATUM 28.5XD2 SP. 090408	●	28.5	25	34	134	56	78	56	0.5	29.5			
ATUM 29XD2 SP. 090408	●	29	25	34	136	58	80	56	0.5	30			
ATUM 29.5XD2 SP. 090408	●	29.5	25	34	136	58	80	56	0.5	30.5			
ATUM 30XD2 SP. 090408	●	30	32	44	147	60	87	60	0.5	31			
ATUM 31XD2 SP. 090408	●	31	32	44	149	62	89	60	0.25	31.5			
ATUM 32XD2 SP. 090408	●	32	32	44	151	64	91	60	0	32			
ATUM 33XD2 SP. 090408	●	33	32	44	153	66	93	60	0	33			
ATUM 34XD2 SP. 110408	●	34	32	44	155	68	95	60	0.5	35	SP. 110408	4015-M4x11	80-T15
ATUM 35XD2 SP. 110408	●	35	32	44	157	70	97	60	0.5	36			
ATUM 36XD2 SP. 110408	●	36	32	44	159	72	99	60	0.5	37			
ATUM 37XD2 SP. 110408	●	37	32	44	161	74	101	60	0.5	38			
ATUM 38XD2 SP. 110408	●	38	32	44	163	76	103	60	0.5	39			
ATUM 39XD2 SP. 110408	●	39	32	44	165	78	105	60	0.5	40			
ATUM 40XD2 SP. 110408	●	40	32	44	167	80	107	60	0.25	40.5			
ATUM 41XD2 SP. 110408	●	41	32	44	169	82	109	60	0	41			
ATUM 42XD2 SP. 140512	●	42	32	44	171	84	111	60	0.5	43	SP. 140512	1020-M5x11	80-T20
ATUM 43XD2 SP. 140512	●	43	32	44	173	86	113	60	0.5	44			
ATUM 44XD2 SP. 140512	●	44	32	44	175	88	115	60	0.5	45			
ATUM 45XD2 SP. 140512	●	45	40	54	192	90	122	70	0.5	46			
ATUM 46XD2 SP. 140512	●	46	40	54	194	92	124	70	0.5	47			
ATUM 47XD2 SP. 140512	●	47	40	54	196	94	126	70	0.5	48			
ATUM 48XD2 SP. 140512	●	48	40	54	198	96	128	70	0.25	48.5			
ATUM 49XD2 SP. 140512	●	49	40	54	200	98	130	70	0	49			
ATUM 50XD2 SP. 140512	●	50	40	54	202	100	132	70	0	50			

R: Sağ / Right / Rechts L: Sol/Left/Links

● Stokta / In Stock / Auf Lager ○ Stokta Yok / Non Stock Item / Kein Lagerartikel, Lieferzeit auf Anfrage
TGTC Ucuna Uygunudur. / Compatible with TGTC Insert. / Kompatibel mit TGTC Wendeplatten.

Sipariş Örneği/Ordering Example/Bestellbeispiel

1 ad./pcs./stück ATUM 28XD2 SP. 090408

Takma Uçlu Matkap Kullanım Kılavuzu : S 367 / User's Guide For U-Drills : P 367
S.368 / Bedienungsanleitung für Vollbohrer



Delme Derinliği
Drilling Depth
Bohrtiefe

= 3xÇap
= 3xDiameter
= 3xDurchmesser

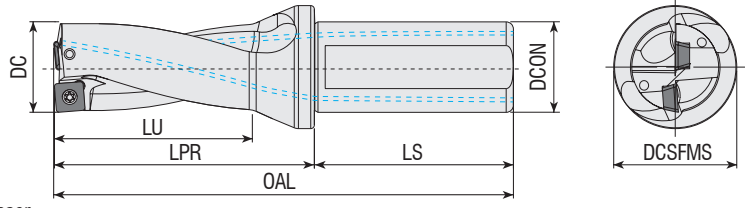

Takım Kodu
Ordering Code
Bestell-Bezeichnung

Stok
Stock
Lager

Takım Ölçüleri (mm)
Dimension (mm)
Abmessung (mm)

Maks. Ofset (radyal)
Max. Offset (radial)
Max. Versatz (radial)

Kesici Uç
Insert
Wendeschneidplatte

Yedek Parçaları / Spare Parts / Ersatzteile

Sıkma Vidası
Screw
Schraube

Tork Anahtar
Torx Key
Torx-Schlüssel

DC DCON DCSFMS OAL LU LPR LS

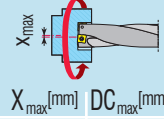

Takım Kodu Ordering Code Bestell-Bezeichnung	Stok Stock Lager	Takım Ölçüleri (mm) Dimension (mm) Abmessung (mm)							Maks. Ofset (radyal) Max. Offset (radial) Max. Versatz (radial)		Kesici Uç Insert Wendeschneidplatte	Sıkma Vidası Screw Schraube	Tork Anahtar Torx Key Torx-Schlüssel
		DC	DCON	DCSFMS	OAL	LU	LPR	LS	X _{max} [mm]	DC _{max} [mm]			
ATUM 12.5XD3 SP. 050204	●	12.5	20	25	108	36	58	50	0.5	13.5	SP. 050204	3006-M2x4	80-T06
ATUM 13XD3 SP. 050204	●	13	20	25	111	39	61	50	0.5	14			
ATUM 13.5XD3 SP. 050204	●	13.5	20	25	111	39	61	50	0.5	14.5			
ATUM 14XD3 SP. 050204	●	14	20	25	114	42	64	50	0.5	15			
ATUM 14.5XD3 SP. 050204	●	14.5	20	25	114	42	64	50	0.5	15.5			
ATUM 15XD3 SP. 050204	●	15	20	25	117	45	67	50	0.5	16			
ATUM 15.5XD3 SP. 060204	●	15.5	20	25	117	45	67	50	0.5	16.5			
ATUM 16XD3 SP. 060204	●	16	25	34	126	48	70	56	0.5	17			
ATUM 16.5XD3 SP. 060204	●	16.5	25	34	126	48	70	56	0.5	17.5			
ATUM 17XD3 SP. 060204	●	17	25	34	129	51	73	56	0.5	18			
ATUM 17.5XD3 SP. 060204	●	17.5	25	34	129	51	73	56	0.5	18.5			
ATUM 18XD3 SP. 060204	●	18	25	34	132	54	76	56	0.5	19			
ATUM 18.5XD3 SP. 060204	●	18.5	25	34	132	54	76	56	0.5	19.5			
ATUM 19XD3 SP. 060204	●	19	25	34	135	57	79	56	0.25	19.5			
ATUM 19.5XD3 SP. 060204	●	19.5	25	34	135	57	79	56	0.25	20			
ATUM 20XD3 SP. 060204	●	20	25	34	138	60	82	56	0	20			
ATUM 20.5XD3 SP. 060204	●	20.5	25	34	138	60	82	56	0	20.5			
ATUM 21XD3 SP. 060204	●	21	25	34	141	63	85	56	0	21			
ATUM 21.5XD3 SP. 060204	●	21.5	25	34	141	63	85	56	0	21.5			
ATUM 22XD3 SP. 07T308	●	22	25	34	144	66	88	56	0.5	23			
ATUM 22.5XD3 SP. 07T308	●	22.5	25	34	144	66	88	56	0.5	23.5			
ATUM 23XD3 SP. 07T308	●	23	25	34	147	69	91	56	0.5	24			
ATUM 23.5XD3 SP. 07T308	●	23.5	25	34	147	69	91	56	0.5	24.5			
ATUM 24XD3 SP. 07T308	●	24	25	34	150	72	94	56	0.5	25			
ATUM 24.5XD3 SP. 07T308	●	24.5	25	34	150	72	94	56	0.5	25.5			
ATUM 25XD3 SP. 07T308	●	25	25	34	153	75	97	56	0.25	25.5			
ATUM 25.5XD3 SP. 07T308	●	25.5	25	34	153	75	97	56	0.25	26			
ATUM 26XD3 SP. 07T308	●	26	25	34	156	78	100	56	0	26			
ATUM 26.5XD3 SP. 07T308	●	26.5	25	34	156	78	100	56	0	26.5			
ATUM 27XD3 SP. 07T308	●	27	25	34	159	81	103	56	0	27			
ATUM 27.5XD3 SP. 07T308	●	27.5	25	34	159	81	103	56	0	27.5			
ATUM 28XD3 SP. 090408	●	28	25	34	162	84	106	56	0.5	29			
ATUM 28.5XD3 SP. 090408	●	28.5	25	34	162	84	106	56	0.5	29.5			
ATUM 29XD3 SP. 090408	●	29	25	34	165	87	109	56	0.5	30			
ATUM 29.5XD3 SP. 090408	●	29.5	25	34	165	87	109	56	0.5	30.5			
ATUM 30XD3 SP. 090408	●	30	32	44	177	90	117	60	0.5	31			
ATUM 30.5XD3 SP. 090408	●	30.5	32	44	177	90	117	60	0.5	31.5			
ATUM 31XD3 SP. 090408	●	31	32	44	180	93	120	60	0.25	31.5			
ATUM 31.5XD3 SP. 090408	●	31.5	32	44	180	93	120	60	0.25	32			
ATUM 32XD3 SP. 090408	●	32	32	44	183	96	123	60	0	32			
ATUM 32.5XD3 SP. 090408	●	32.5	32	44	183	96	123	60	0	32.5			
ATUM 33XD3 SP. 090408	●	33	32	44	186	99	126	60	0	33			
ATUM 33.5XD3 SP. 090408	●	33.5	32	44	186	99	126	60	0	33.5			

R: Sağ / Right / Rechts L: Sol/Left/Links
● Stokta / In Stock / Auf Lager ○ Stokta Yok / Non Stock Item / Kein Lagerartikel, Lieferzeit auf Anfrage
TGTC Ucuna Uygunudur. / Compatible with TGTC Insert. / Kompatibel mit TGTC Wendepplatten.

Sipariş Örneği/Ordering Example/Bestellbeispiel
1 ad./pcs./stück ATUM 12.5XD3 SP. 050204
Takma Uçlu Matkap Kullanım Kılavuzu : S 367 / User's Guide For U-Drills : P 367
S.368 / Bedienungsanleitung für Vollbohrer
210 / 211



Delme Derinliği = 3xÇap
Drilling Depth = 3xDiameter
Bohrtiefe = 3xDurchmesser

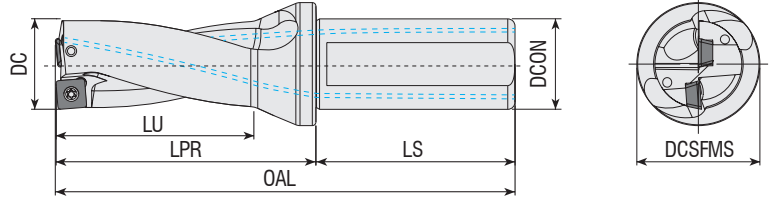

Takım Kodu Ordering Code Bestell-Bezeichnung	Stok Stock Lager	Takım Ölçüleri (mm) Dimension (mm) Abmessung (mm)							Maks. Ofset (radyal) Max. Offset (radial) Max. Versatz (radial)		Kesici Uç Insert Wendescheidplatte	Yedek Parçaları / Spare Parts / Ersatzteile	
		DC	DCON	DCSFMS	OAL	LU	LPR	LS	X _{max}	DC _{max}		Sıkma Vidası Screw Schraube	Tork Anahtar Torx Key Torx-Schlüssel
ATUM 34XD3 SP. 110408	●	34	32	44	189	102	129	60	1.4	30.8	SP. 110408	4015-M4x11	80-T15
ATUM 34.5XD3 SP. 110408	●	34.5	32	44	189	102	129	60	1.4	31.3			
ATUM 35XD3 SP. 110408	●	35	32	44	192	105	132	60	1.4	31.8			
ATUM 35.5XD3 SP. 110408	●	35.5	32	44	192	105	132	60	1.4	32.3			
ATUM 36XD3 SP. 110408	●	36	32	44	195	108	135	60	2.4	34.8			
ATUM 36.5XD3 SP. 110408	●	36.5	32	44	195	108	135	60	2.3	35.6			
ATUM 37XD3 SP. 110408	●	37	32	44	198	111	138	60	2.1	36.2			
ATUM 37.5XD3 SP. 110408	●	37.5	32	44	198	111	138	60	1.9	36.8			
ATUM 38XD3 SP. 110408	●	38	32	44	201	114	141	60	1.9	37.8			
ATUM 38.5XD3 SP. 110408	●	38.5	32	44	201	114	141	60	1.8	38.6			
ATUM 39XD3 SP. 110408	●	39	32	44	204	117	144	60	1.7	39.4			
ATUM 39.5XD3 SP. 110408	●	39.5	32	44	204	117	144	60	1.6	40.2			
ATUM 40XD3 SP. 110408	●	40	32	44	207	120	147	60	1.5	41			
ATUM 40.5XD3 SP. 110408	●	40.5	32	44	207	120	147	60	1.3	41.6			
ATUM 41XD3 SP. 110408	●	41	32	44	210	123	150	60	1	42			
ATUM 41.5XD3 SP. 110408	●	41.5	32	44	210	123	150	60	0.8	42.6			
ATUM 42XD3 SP. 140512	●	42	32	44	213	126	153	60	0.5	43	SP. 140512	1020-M5x11	80-T20
ATUM 42.5XD3 SP. 140512	●	42.5	32	44	213	126	153	60	0.3	43.6			
ATUM 43XD3 SP. 140512	●	43	32	44	216	129	156	60	0	44			
ATUM 43.5XD3 SP. 140512	●	43.5	32	44	216	129	156	60	3.3	51.6			
ATUM 44XD3 SP. 140512	●	44	32	44	219	132	159	60	3	52			
ATUM 44.5XD3 SP. 140512	●	44.5	32	44	219	132	159	60	2.8	52.6			
ATUM 45XD3 SP. 140512	●	45	40	54	237	135	167	70	2.5	53			
ATUM 45.5XD3 SP. 140512	●	45.5	40	54	237	135	167	70	2.2	53.4			
ATUM 46XD3 SP. 140512	●	46	40	54	240	138	170	70	2	54			
ATUM 47XD3 SP. 140512	●	47	40	54	243	141	173	70	0.2	47.4			
ATUM 48XD3 SP. 140512	●	48	40	54	246	144	176	70	0	48			
ATUM 49XD3 SP. 140512	●	49	40	54	249	147	179	70	0	49			
ATUM 50XD3 SP. 140512	●	50	40	54	252	150	182	70	0	50			
ATUM 51XD3 SP. 140512	●	51	40	54	255	153	185	70	0	51			
ATUM 52XD3 SP. 140512	●	52	40	54	258	156	188	70	0	52			

R: Sağ / Right / Rechts L: Sol/Left/Links

● Stokta / In Stock / Auf Lager ○ Stokta Yok / Non Stock Item / Kein Lagerartikel, Lieferzeit auf Anfrage
TGTC Ucuna Uygunudur. / Compatible with TGTC Insert. / Kompatibel mit TGTC Wendeplatten.

Sipariş Örneği/Ordering Example/Bestellbeispiel

1 ad./pcs./stück ATUM 34XD3 SP. 110408

Takma Uçlu Matkap Kullanım Kılavuzu : S 367 / User's Guide For U-Drills : P 367
S.368 / Bedienungsanleitung für Vollbohrer



Delme Derinliği
Drilling Depth
Bohrtiefe

= 4xÇap
= 4xDiameter
= 4xDurchmesser

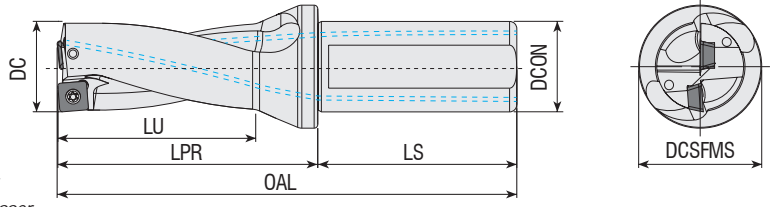

Takım Kodu
Ordering Code
Bestell-Bezeichnung

Stok
Stock
Lager

Takım Ölçüleri (mm)
Dimension (mm)
Abmessung (mm)

Maks. Ofset (radial)
Max. Offset (radial)
Max. Versatz (radial)

Kesici Uç
Insert
Wendeschneidplatte

Yedek Parçaları / Spare Parts / Ersatzteile

Sıkma Vidası
Screw
Schraube

Tork Anahtar
Torx Key
Torx-Schlüssel

ATUM	Model	SP.	Part No.	Stok	DC	DCON	DCSFMS	OAL	LU	LPR	LS	Maks. Ofset (radial)		Kesici Uç	Sıkma Vidası	Tork Anahtar
												X_{max}	DC_{max}			
ATUM	13XD4	SP.	050204	●	13	20	25	124	52	74	50	0.5	14			
ATUM	14XD4	SP.	050204	●	14	20	25	128	56	78	50	0.5	15	SP. 050204	3006-M2x4	80-T06
ATUM	15XD4	SP.	050204	●	15	20	25	132	60	82	50	0.5	16			
ATUM	16XD4	SP.	060204	●	16	25	34	142	64	86	56	0.5	17			
ATUM	17XD4	SP.	060204	●	17	25	34	146	68	90	56	0.5	18			
ATUM	17.5XD4	SP.	060204	●	17	25	34	146	68	90	56	0.5	18.5			
ATUM	18XD4	SP.	060204	●	18	25	34	150	72	94	56	0.5	19	SP. 060204	3007-M2.2x5	80-T07
ATUM	19XD4	SP.	060204	●	19	25	34	154	76	98	56	0.25	19.5			
ATUM	19.5XD4	SP.	060204	●	19.5	25	34	154	76	98	56	0.25	20			
ATUM	20XD4	SP.	060204	●	20	25	34	158	80	102	56	0	20			
ATUM	21XD4	SP.	060204	●	21	25	34	162	84	106	56	0	21			
ATUM	22XD4	SP.	07T308	●	22	25	34	166	88	110	56	0.5	23			
ATUM	23XD4	SP.	07T308	●	23	25	34	170	92	114	56	0.5	24			
ATUM	23.5XD4	SP.	07T308	●	23.5	25	34	170	92	114	56	0.5	24.5			
ATUM	24XD4	SP.	07T308	●	24	25	34	174	96	118	56	0.5	25	SP. 07T308	3008-M2.5x6	80-T08
ATUM	25XD4	SP.	07T308	●	25	25	34	178	100	122	56	0.25	25.5			
ATUM	26XD4	SP.	07T308	●	26	25	34	182	104	126	56	0	26			
ATUM	27XD4	SP.	07T308	●	27	25	34	186	108	130	56	0	27			
ATUM	27.5XD4	SP.	07T308	●	27.5	25	34	186	108	130	56	0	27.5			
ATUM	28XD4	SP.	090408	●	28	25	34	190	112	134	56	0.5	29			
ATUM	29XD4	SP.	090408	●	29	25	34	194	116	138	56	0.5	30			
ATUM	30XD4	SP.	090408	●	30	32	44	207	120	147	60	0.5	31			
ATUM	31XD4	SP.	090408	●	31	32	44	211	124	151	60	0.25	31.5	SP. 090408	4015-M3.5x9	80-T15
ATUM	32XD4	SP.	090408	●	32	32	44	215	128	155	60	0	32			
ATUM	33XD4	SP.	090408	●	33	32	44	219	132	159	60	0	33			
ATUM	33.5XD4	SP.	090408	●	33.5	32	44	219	132	159	60	0	33.5			
ATUM	34XD4	SP.	110408	●	34	32	44	223	136	163	60	0.5	35			
ATUM	35XD4	SP.	110408	●	35	32	44	227	140	167	60	0.5	36			
ATUM	36XD4	SP.	110408	●	36	32	44	231	144	171	60	0.5	37			
ATUM	37XD4	SP.	110408	●	37	32	44	235	148	175	60	0.5	38			
ATUM	38XD4	SP.	110408	●	38	32	44	239	152	179	60	0.5	39	SP. 110408	4015-M4x11	80-T15
ATUM	39XD4	SP.	110408	●	39	32	44	243	156	183	60	0.5	40			
ATUM	40XD4	SP.	110408	●	40	32	44	247	160	187	60	0.25	40.5			
ATUM	41XD4	SP.	110408	●	41	32	44	251	164	191	60	0	41			
ATUM	42XD4	SP.	140512	●	42	32	44	255	168	195	60	0.5	43			
ATUM	43XD4	SP.	140512	●	43	32	44	259	172	199	60	0.5	44	SP. 140512	1020-M5x11	80-T20
ATUM	44XD4	SP.	140512	●	44	32	44	263	176	203	60	0.5	45			

R: Sağ / Right / Rechts L: Sol/Left/Links
● Stokta / In Stock / Auf Lager ○ Stokta Yok / Non Stock Item / Kein Lagerartikel, Lieferzeit auf Anfrage
TGTC Ucuna Uygundur. / Compatible with TGTC Insert. / Kompatibel mit TGTC Wendepplatten.

Sipariş Örneği/Ordering Example/Bestellbeispiel

1 ad./pcs./stück ATUM 13XD4 SP. 050204

Takma Uçlu Matkap Kullanım Kılavuzu : S 367 / User's Guide For U-Drills : P 367

S.368 / Bedienungsanleitung für Vollbohrer

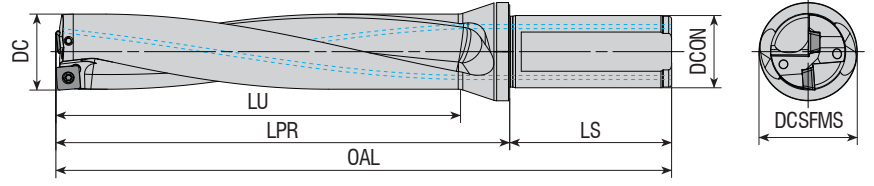

Delme Derinliği = 5xÇap
Drilling Depth = 5xDiameter
Bohrtiefe = 5xDurchmesser

Takım Kodu Ordering Code Bestell-Bezeichnung	Stok Stock Lager	Takım Ölçüleri (mm) Dimension (mm) Abmessung (mm)							Maks. Ofset (radyal) Max. Offset (radial) Max. Versatz (radial)	Kesici Uç Insert Wendeschneidplatte	Yedek Parçaları / Spare Parts / Ersatzteile		
		DC	DCON	DCSFMS	OAL	LU	LPR	LS			Sıkma Vidası Screw Schraube	Tork Anahtar Torx Key Torx-Schlüssel	
ATUM 14XD5 SP. 050204	●	14	20	25	142	70	92	50	0.5	15.00	SP. 050204	3006-M2x4	80-T06
ATUM 16XD5 SP. 060204	●	16	25	34	158	80	102	56	0.5	17.00	SP. 060204	3007-M2.2x5	80-T07
ATUM 17XD5 SP. 060204	●	17	25	34	163	85	107	56	0.5	18.00			
ATUM 18XD5 SP. 060204	●	18	25	34	168	90	112	56	0.5	19.00			
ATUM 19XD5 SP. 060204	●	19	25	34	173	95	117	56	0.25	19.50			
ATUM 20XD5 SP. 060204	●	20	25	34	178	100	122	56	0	20.00			
ATUM 21XD5 SP. 060204	●	21	25	34	183	105	127	56	0	21.00			
ATUM 22XD5 SP. 07T308	●	22	25	34	188	110	132	56	0.5	23.00	SP. 07T308	3008-M2.5x6	80-T08
ATUM 22XD5 SP. 07T308-32	●	22	32	44	197	110	137	60	0.5	23.00			
ATUM 23XD5 SP. 07T308	●	23	25	34	193	115	137	56	0.5	24.00			
ATUM 23XD5 SP. 07T308-32	●	23	32	44	202	115	142	60	0.5	24.00			
ATUM 24XD5 SP. 07T308-32	●	24	32	44	207	120	147	60	0.5	25.00			
ATUM 25XD5 SP. 07T308	●	25	25	34	203	125	147	56	0.25	25.50			
ATUM 25XD5 SP. 07T308-32	●	25	32	44	212	125	152	60	0.25	25.50			
ATUM 26XD5 SP. 07T308	●	26	25	34	208	130	152	56	0	26.00			
ATUM 26XD5 SP. 07T308-32	●	26	32	44	217	130	157	60	0	26.00			
ATUM 27XD5 SP. 07T308	●	27	25	34	213	135	157	56	0	27.00			
ATUM 27XD5 SP. 07T308-32	●	27	32	44	222	135	162	60	0	27.00			
ATUM 28XD5 SP. 090408-32	●	28	32	44	227	140	167	60	0.5	29.00	SP. 090408	4015-M3.5x9	80-T15
ATUM 29XD5 SP. 090408-32	●	29	32	44	232	145	172	60	0.5	30.00			
ATUM 30XD5 SP. 090408	●	30	32	44	237	150	177	60	0.5	31.00			
ATUM 31XD5 SP. 090408	●	31	32	44	242	155	182	60	0.25	31.50			
ATUM 32XD5 SP. 090408	●	32	32	44	247	160	187	60	0	32.00			
ATUM 33XD5 SP. 090408	●	33	32	44	252	165	192	60	0	33.00			

R: Sağ / Right / Rechts L: Sol/Left/Links
● Stokta / In Stock / Auf Lager ○ Stokta Yok / Non Stock Item / Kein Lagerartikel, Lieferzeit auf Anfrage
TGTC Ucuna Uygunudur. / Compatible with TGTC Insert. / Kompatibel mit TGTC Wendeplatten.

Sipariş Örneği/Ordering Example/Bestellbeispiel
1 ad./pcs./stück ATUM 14XD5 SP. 050204
Takma Uçlu Matkap Kullanım Kılavuzu : S 367 / User's Guide For U-Drills : P 367
S.368 / Bedienungsanleitung für Vollbohrer



Delme Derinliği
Drilling Depth
Bohrtiefe

= 2xÇap
= 2xDiameter
= 2xDurchmesser

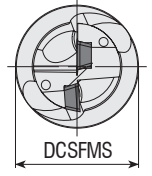
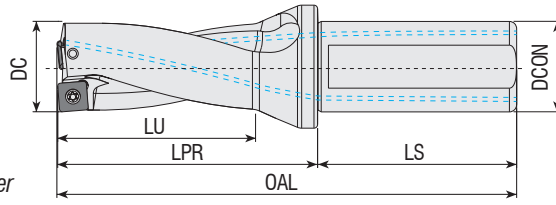

Takım Kodu
Ordering Code
Bestell-Bezeichnung

Stok Stock Lager	Takım Ölçüleri (mm) Dimension (mm) Abmessung (mm)								Maks. Ofset (radyal) Max. Offset (radial) Max. Versatz (radial)		Kesici Uç Insert Wendeschneidplatte	Yedek Parçaları / Spare Parts / Ersatzteile	
	DC	DCON	DCSFMS	OAL	LU	LPR	LS	X _{max}	X _{max} [mm]	DC _{max} [mm]		Sıkma Vidası Screw Schraube	Tork Anahtar Torx Key Torx-Schlüssel
●	12.5	20	25	96	24	46	50	0.5	13.5	SPGT 050204	3006-M2x4	80-T06	
●	13	20	25	98	26	48	50	0.5	14				
●	13.5	20	25	98	26	48	50	0.5	14.5				
●	14	20	25	100	28	50	50	0.5	15				
●	15	20	25	102	30	52	50	0.5	16				
●	16	25	34	110	32	54	56	0.5	17	SPGT 060204	3007-M2.2x5	80-T07	
●	16.5	25	34	110	32	54	56	0.5	17.5				
●	17	25	34	112	34	56	56	0.5	18				
●	17.5	25	34	112	34	56	56	0.5	18.5				
●	18	25	34	114	36	58	56	0.5	19				
●	19	25	34	116	38	60	56	0.25	19.5	SPGT 07T308	3008-M2.5x6	80-T08	
●	20	25	34	118	40	62	56	0	20				
●	22	25	34	122	44	66	56	0.5	23				
●	22.5	25	34	122	44	66	56	0.5	23.5				
●	23	25	34	124	46	68	56	0.5	24				
●	24	25	34	126	48	70	56	0.5	25	SPGT 090408	4015-M3.5x9	80-T15	
●	25	25	34	128	50	72	56	0.25	25.5				
●	26	25	34	130	52	74	56	0	26				
●	28	25	34	134	56	78	56	0.5	29				
●	29	25	34	136	58	80	56	0.5	30				
●	30	32	44	147	60	87	60	0.5	31	SPGT 110408	4015-M4x11	80-T15	
●	32	32	44	151	64	91	60	0	32				
●	35	32	44	157	70	97	60	0.5	36				
●	36	32	44	159	72	99	60	0.5	37				
●	40	32	44	167	80	107	60	0.25	40.5				

R: Sağ / Right / Rechts L: Sol/Left/Links

● Stokta / In Stock / Auf Lager ○ Stokta Yok / Non Stock Item / Kein Lagerartikel, Lieferzeit auf Anfrage
ZCC Ucuna Uygundur. / Compatible with ZCC Insert. / Kompatibel mit ZCC Wendeplatten.

Sipariş Örneği/Ordering Example/Bestellbeispiel

1 ad./pcs./stück ATUM 12.5XD2 SPGT 050204

Takma Uçlu Matkap Kullanım Kılavuzu : S 367 / User's Guide For U-Drills : P 367

S.368 / Bedienungsanleitung für Vollbohrer





Delme Derinliği
Drilling Depth
Bohrtiefe

= 3xÇap
= 3xDiameter
= 3xDurchmesser

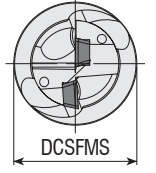
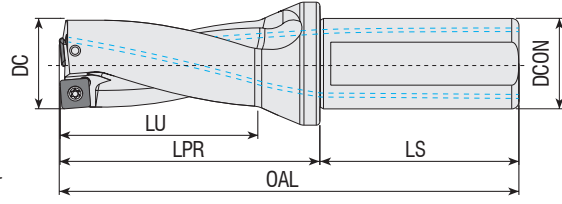

Takım Kodu
Ordering Code
Bestell-Bezeichnung

Stok Stock Lager	Takım Ölçüleri (mm) Dimension (mm) Abmessung (mm)								Maks. Ofset (radyal) Max. Offset (radial) Max. Versatz (radial)		Kesici Uç Insert Wendeschneidplatte	Yedek Parçaları / Spare Parts / Ersatzteile	
	DC	DCON	DCSFMS	OAL	LU	LPR	LS	X _{max}	X _{max} [mm]	DC _{max} [mm]		Sıkma Vidası Screw Schraube	Tork Anahtar Torx Key Torx-Schlüssel
●	12.5	20	25	108	36	58	50	0.5	13.5	SPGT 050204	3006-M2x4	80-T06	
●	13	20	25	111	39	61	50	0.5	14				
●	13.5	20	25	111	39	61	50	0.5	14.5				
●	14	20	25	114	42	64	50	0.5	15				
●	14.5	20	25	114	42	64	50	0.5	15.5				
●	15	20	25	117	45	67	50	0.5	16				
●	15.5	20	25	117	45	67	50	0.5	16.5	SPGT 060204	3007-M2.2x5	80-T07	
●	16	25	34	126	48	70	56	0.5	17				
●	16.5	25	34	126	48	70	56	0.5	17.5				
●	17	25	34	129	51	73	56	0.5	18				
●	17.5	25	34	129	51	73	56	0.5	18.5				
●	18	25	34	132	54	76	56	0.5	19				
●	18.5	25	34	132	54	76	56	0.5	19.5				
●	19	25	34	135	57	79	56	0.25	19.5				
●	19.5	25	34	135	57	79	56	0.25	20				
●	20	25	34	138	60	82	56	0	20				
●	20.5	25	34	138	60	82	56	0	20.5				
●	21	25	34	141	63	85	56	0	21				
●	21.5	25	34	141	63	85	56	0	21.5				
●	22	25	34	144	66	88	56	0.5	23	SPGT 07T308	3008-M2.5x6	80-T08	
●	22.5	25	34	144	66	88	56	0.5	23.5				
●	23	25	34	147	69	91	56	0.5	24				
●	23.5	25	34	147	69	91	56	0.5	24.5				
●	24	25	34	150	72	94	56	0.5	25				
●	24.5	25	34	150	72	94	56	0.5	25.5				
●	25	25	34	153	75	97	56	0.25	25.5				
●	25.5	25	34	153	75	97	56	0.25	26				
●	26	25	34	156	78	100	56	0	26				
●	26.5	25	34	156	78	100	56	0	26.5				
●	27	25	34	159	81	103	56	0	27				
●	27.5	25	34	159	81	103	56	0	27.5				
●	28	25	34	162	84	106	56	0.5	29	SPGT 090408	4015-M3.5x9	80-T15	
●	28.5	25	34	162	84	106	56	0.5	29.5				
●	29	25	34	165	87	109	56	0.5	30				
●	29.5	25	34	165	87	109	56	0.5	30.5				
●	30	32	44	177	90	117	60	0.5	31				
●	31	32	44	180	93	120	60	0.25	31.5				
●	32	32	44	183	96	123	60	0	32				
●	32	32	44	183	96	123	60	0	32				
●	33	32	44	186	99	126	60	0	33				

R: Sağ / Right / Rechts L: Sol/Left/Links
● Stokta / In Stock / Auf Lager ○ Stokta Yok / Non Stock Item / Kein Lagerartikel, Lieferzeit auf Anfrage
ZCC Ucuna Uygundur. / Compatible with ZCC Insert. / Kompatibel mit ZCC Wendeschneidplatten.

Sipariş Örneği/Ordering Example/Bestellbeispiel
1 ad./pcs./stück ATUM 12.5XD3 SPGT 050204

Takma Uçlu Matkap Kullanım Kılavuzu : S 367 / User's Guide For U-Drills : P 367
S.368 / Bedienungsanleitung für Vollbohrer



Delme Derinliği = 3xÇap
Drilling Depth = 3xDiameter
Bohrtiefe = 3xDurchmesser

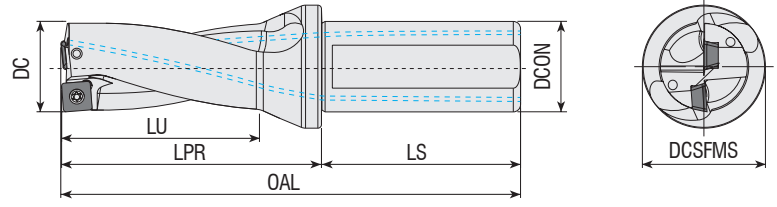

Takım Kodu
Ordering Code
Bestell-Bezeichnung

Stok Stock Lager	Takım Ölçüleri (mm) Dimension (mm) Abmessung (mm)								Maks. Ofset (radyal) Max. Offset (radial) Max. Versatz (radial)		Kesici Uç Insert Wendeschneidplatte	Yedek Parçaları / Spare Parts / Ersatzteile	
	DC	DCON	DCSFMS	OAL	LU	LPR	LS	X _{max}	X _{max} [mm]	DC _{max} [mm]		Sıkma Vidası Screw Schraube	Tork Anahtar Torx Key Torx-Schlüssel
●	34	32	44	189	102	129	60	0.5	35	SPGT 110408	4015-M4x11	80-T15	
●	35	32	44	192	105	132	60	0.5	36				
●	37	32	44	198	111	138	60	0.5	38				
●	38	32	44	201	114	141	60	0.5	39				
●	39	32	44	204	117	144	60	0.5	40				
●	40	32	44	207	120	147	60	0.25	40.5				
●	42	32	44	213	126	153	60	0.5	43	SPGT 140512	1020-M5x11	80-T20	
●	43	32	44	216	129	156	60	0.5	44				
●	44	32	44	219	132	159	60	0.5	45				
●	49	40	54	249	147	179	70	0	49				
●	49	40	54	249	147	179	70	0	49				
●	50	40	54	252	150	182	70	0	50				

R: Sağ / Right / Rechts L: Sol/Left/Links

● Stokta / In Stock / Auf Lager ○ Stokta Yok / Non Stock Item / Kein Lagerartikel, Lieferzeit auf Anfrage
ZCC Ucuna Uygun / Compatible with ZCC Insert. / Kompatibel mit ZCC Wendeschneidplatten.

Sipariş Örneği/Ordering Example/Bestellbeispiel
1 ad./pcs./stück ATUM 34XD3 SPGT 110408

Takma Uçlu Matkap Kullanım Kılavuzu : S 367 / User's Guide For U-Drills : P 367
S.368 / Bedienungsanleitung für Vollbohrer





Delme Derinliği
Drilling Depth
Bohrtiefe

= 4xÇap
= 4xDiameter
= 4xDurchmesser

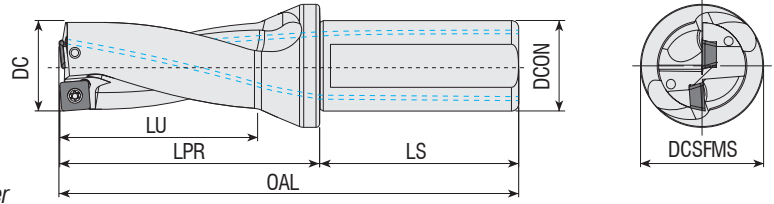

Takım Kodu
Ordering Code
Bestell-Bezeichnung

Stok
Stock
Lager

Takım Ölçüleri (mm)
Dimension (mm)
Abmessung (mm)

Maks. Ofset (radyal)
Max. Ofset (radial)
Max. Versatz (radial)

Kesici Uç
Insert
Wendeschneidplatte

Yedek Parçaları / Spare Parts / Ersatzteile

Sıkma Vidası
Screw
Schraube

Tork Anahtar
Torx Key
Torx-Schlüssel

Takım Kodu Ordering Code Bestell-Bezeichnung	Stok Stock Lager	Takım Ölçüleri (mm) Dimension (mm) Abmessung (mm)								Maks. Ofset (radyal) Max. Ofset (radial) Max. Versatz (radial)		Kesici Uç Insert Wendeschneidplatte	Sıkma Vidası Screw Schraube	Tork Anahtar Torx Key Torx-Schlüssel
		DC	DCON	DCSFMS	OAL	LU	LPR	LS	X _{max} X _{max} [mm]	DC _{max} DC _{max} [mm]				
ATUM 13XD4 SPGT 050204	●	13	20	25	124	52	74	50	0.5	14	SPGT 050204	3006-M2x4	80-T06	
ATUM 14XD4 SPGT 050204	●	14	20	25	128	56	78	50	0.5	15				
ATUM 15XD4 SPGT 050204	●	15	20	25	132	60	82	50	0.5	16				
ATUM 16XD4 SPGT 060204	●	16	25	34	142	64	86	56	0.5	17				
ATUM 17XD4 SPGT 060204	●	17	25	34	146	68	90	56	0.5	18	SPGT 060204	3007-M2.2x5	80-T07	
ATUM 17.5XD4 SPGT 060204	●	17.5	25	34	146	68	90	56	0.5	18.5				
ATUM 18XD4 SPGT 060204	●	18	25	34	150	72	94	56	0.5	19				
ATUM 19XD4 SPGT 060204	●	19	25	34	154	76	98	56	0.25	19.5				
ATUM 19.5XD4 SPGT 060204	●	19.5	25	34	154	76	98	56	0.25	20				
ATUM 20XD4 SPGT 060204	●	20	25	34	158	80	102	56	0	20				
ATUM 21XD4 SPGT 060204	●	21	25	34	162	84	106	56	0	21	SPGT 07T308	3008-M2.5x6	80-T08	
ATUM 22XD4 SPGT 07T308	●	22	25	34	166	88	110	56	0.5	23				
ATUM 23XD4 SPGT 07T308	●	23	25	34	170	92	114	56	0.5	24				
ATUM 23.5XD4 SPGT 07T308	●	23.5	25	34	170	92	114	56	0.5	24.5				
ATUM 24XD4 SPGT 07T308	●	24	25	34	174	96	118	56	0.5	25				
ATUM 25XD4 SPGT 07T308	●	25	25	34	178	100	122	56	0.25	25.5				
ATUM 26XD4 SPGT 07T308	●	26	25	34	182	104	126	56	0	26	SPGT 090408	4015-M3.5x9	80-T15	
ATUM 27.5XD4 SPGT 07T308	●	27.5	25	34	186	108	130	56	0	27.5				
ATUM 28XD4 SPGT 090408	●	28	25	34	190	112	134	56	0.5	29				
ATUM 29XD4 SPGT 090408	●	29	25	34	194	116	138	56	0.5	30				
ATUM 30XD4 SPGT 090408	●	30	32	44	207	120	147	60	0.5	31				
ATUM 33.5XD4 SPGT 090408	●	33.5	32	44	219	132	159	60	0	33.5				
ATUM 38XD4 SPGT 110408	●	38	32	44	239	152	179	60	0.5	39	SPGT 110408	4015-M4x11	80-T15	

R: Sağ / Right / Rechts L: Sol/Left/Links

● Stokta / In Stock / Auf Lager ○ Stokta Yok / Non Stock Item / Kein Lagerartikel, Lieferzeit auf Anfrage
ZCC Ucuna Uygun. / Compatiple with ZCC Insert. / Kompatibel mit ZCC Wendeplatten.

Sipariş Örneği/Ordering Example/Bestellbeispiel

1 ad./pcs./stück ATUM 13XD4 SPGT 050204

Takma Uçlu Matkap Kullanım Kılavuzu : S 367 / User's Guide For U-Drills : P 367

S.368 / Bedienungsanleitung für Vollbohrer





Delme Derinliği
Drilling Depth
Bohrtiefe
= 3xÇap
= 3xDiameter
= 3xDurchmesser

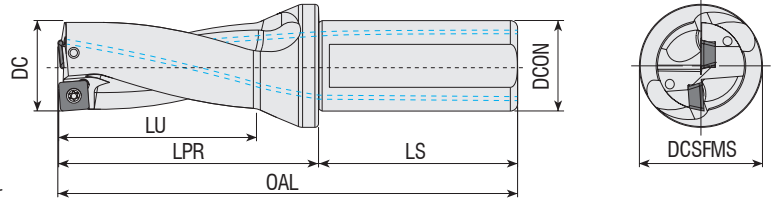

Takım Kodu
Ordering Code
Bestell-Bezeichnung

Stok
Stock
Lager

Takım Ölçüleri (mm)
Dimension (mm)
Abmessung (mm)

Maks. Ofset (radyal)
Max. Offset (radial)
Max. Versatz (radial)

Kesici Uç
Insert
Wendeschneidplatte

Yedek Parçaları / Spare Parts / Ersatzteile

Sıkma Vidası
Screw
Schraube

Tork Anahtar
Torx Key
Torx-Schlüssel

Takım Kodu Ordering Code Bestell-Bezeichnung	Stok Stock Lager	Takım Ölçüleri (mm) Dimension (mm) Abmessung (mm)							Maks. Ofset (radyal) Max. Offset (radial) Max. Versatz (radial)		Kesici Uç Insert Wendeschneidplatte	Sıkma Vidası Screw Schraube	Tork Anahtar Torx Key Torx-Schlüssel
		DC	DCON	DCSFMS	OAL	LU	LPR	LS	X _{max}	DC _{max}			
ATUM 14XD3 SO.. 050204	●	14	20	25	114	42	64	50	1.4	16.8	SO.. 050204	3006-M2x4	80-T06
ATUM 15XD3 SO.. 050204	●	15	20	25	117	45	67	50	1.2	17.4			
ATUM 16XD3 SO.. 050204	●	16	25	34	126	48	70	56	0.9	17.8			
ATUM 16.5XD3 SO.. 050204	●	16.5	25	34	126	48	70	56	0.8	18.1			
ATUM 17XD3 SO.. 050204	●	17	25	34	129	51	73	56	0.65	18.3			
ATUM 17.5XD3 SO.. 050204	●	17.5	25	34	129	51	73	56	0.5	18.5			
ATUM 18XD3 SO.. 060304	●	18	25	34	132	54	76	56	1.15	20.3	SO.. 060304	3007-M2.2x5	80-T07
ATUM 19XD3 SO.. 060204	●	19	25	34	135	57	79	56	0.9	20.8			
ATUM 20XD3 SO.. 060304	●	20	25	34	138	60	82	56	0.65	21.3			
ATUM 21XD3 SO.. 070305	●	21	25	34	141	63	85	56	1.75	24.5	SO.. 070305	3008-M2.5x6	80-T08
ATUM 22XD3 SO.. 070305	●	22	25	34	144	66	88	56	1.5	25			
ATUM 22.5XD3 SO.. 070305	●	22.5	25	34	144	66	88	56	1.35	25.2			
ATUM 23XD3 SO.. 070305	●	23	25	34	147	69	91	56	1.25	25.5			
ATUM 24XD3 SO.. 070305	●	24	25	34	150	72	94	56	1	26			
ATUM 25XD3 SO.. 09T306	●	25	25	34	153	75	97	56	2.25	29.5			
ATUM 26XD3 SO.. 09T306	●	26	25	34	156	78	100	56	2	30	SO.. 09T306	4010-M3x8	80-T10
ATUM 27XD3 SO.. 09T306	●	27	25	34	159	81	103	56	1.75	30.5			
ATUM 29XD3 SO.. 09T306	●	29	25	34	174	87	114	56	1.25	31.5			
ATUM 30XD3 SO.. 09T306	●	30	32	44	177	90	117	60	1	32			
ATUM 31XD3 SO.. 09T306	●	31	32	44	200	93	120	60	0.75	32.5			
ATUM 33XD3 SO.. 09T306	●	33	32	44	186	99	126	60	0.5	34			
ATUM 35XD3 SO.. 120408	●	35	32	44	192	105	132	60	2.75	40.5	SO..120408	4015-M4X11	80-T15
ATUM 36XD3 SO.. 120408	●	36	32	44	195	108	135	60	2.5	41			
ATUM 37XD3 SO.. 120408	●	37	32	44	198	111	138	60	2.25	41.5			
ATUM 38XD3 SO.. 120408	●	38	32	44	201	114	141	60	1.75	41.5			
ATUM 39XD3 SO.. 120408	●	39	32	44	204	117	144	60	1.75	42.5			
ATUM 40XD3 SO.. 120408	●	40	32	44	207	120	147	60	1.5	43			
ATUM 43XD3 SO.. 120408	●	43	32	44	216	129	156	60	0.75	44.5			

R: Sağ / Right / Rechts L: Sol/Left/Links

● Stokta / In Stock / Auf Lager ○ Stokta Yok / Non Stock Item / Kein Lagerartikel, Lieferzeit auf Anfrage
ISCR Ucuna Uygun / Compatible with ISCR Insert. / Kompatibel mit ISCR Wendepfetten.

Sipariş Örneği/Ordering Example/Bestellbeispiel

1 ad./pcs./stück ATUM 14XD3 SO.. 050204

Takma Uçlu Matkap Kullanım Kılavuzu : S 367 / User's Guide For U-Drills : P 367

S.368 / Bedienungsanleitung für Vollbohrer



Delme Derinliği
Drilling Depth
Bohrtiefe

= 4xÇap
= 4xDiameter
= 4xDurchmesser

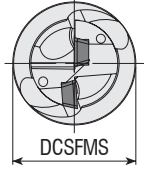
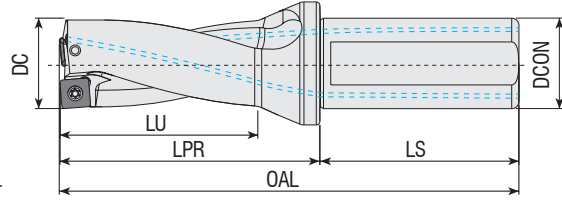

Takım Kodu Ordering Code Bestell-Bezeichnung	Stok Stock Lager	Takım Ölçüleri (mm) Dimension (mm) Abmessung (mm)							Maks. Ofset (radyal) Max. Offset (radial) Max. Versatz (radial)		Kesici Uç Insert Wendeschneidplatte	Yedek Parçaları / Spare Parts / Ersatzteile	
		DC	DCON	DCSFMS	OAL	LU	LPR	LS	X _{max}	DC _{max}		Sıkma Vidası Screw Schraube	Tork Anahtar Torx Key Torx-Schlüssel
ATUM 14XD4 SO.. 050204	●	14	20	25	128	56	78	50	1.4	16.8	SO.. 050204	3006-M2x4	80-T06
ATUM 14.5XD4 SO.. 050204	●	14.5	20	25	128	56	78	50	1.3	17.1			
ATUM 15XD4 SO.. 050204	●	15	20	25	132	60	62	50	1.2	17.4			
ATUM 15.5XD4 SO.. 050204	●	15.5	20	25	132	60	82	50	1	17.5			
ATUM 17XD4 SO.. 050204	●	17	25	34	146	68	90	56	0.65	18.3	SO.. 060304	3007-M2.2x5	80-T07
ATUM 19XD4 SO.. 060304	●	19	25	34	154	76	98	56	0.9	20.8			
ATUM 19.5XD4 SO.. 060304	●	19.5	25	34	154	76	98	56	0.75	21			
ATUM 20XD4 SO.. 060304	●	20	25	34	158	80	102	56	0.65	21.3			
ATUM 21XD4 SO.. 070305	●	21	25	34	162	84	106	56	1.75	24.5	SO.. 070305	3008-M2.5x6	80-T08
ATUM 22XD4 SO.. 070305	●	22	25	34	166	88	110	56	1.5	25			
ATUM 22.5XD4 SO.. 070305	●	22.5	25	34	166	88	110	56	1.35	25.2			
ATUM 23XD4 SO.. 070305	●	23	25	34	170	92	114	56	1.25	25.5			
ATUM 24XD4 SO.. 070305	●	24	25	34	174	96	118	56	1	26	SO.. 09T306	4010-M3x8	80-T10
ATUM 25XD4 SO.. 09T306	●	25	25	34	178	100	122	56	2.25	29.5			
ATUM 27XD4 SO.. 09T306	●	27	25	34	186	108	130	56	1.75	30.5			
ATUM 28XD4 SO.. 09T306	●	28	25	34	190	112	134	56	1.5	31			
ATUM 29XD4 SO.. 09T306	●	29	25	34	194	116	138	56	1.25	31.5	SO.. 120408	4015-M4X11	80-T15
ATUM 30XD4 SO.. 09T306	●	30	32	44	207	120	147	60	1	32			
ATUM 31XD4 SO.. 09T306	●	31	32	44	211	124	151	60	0.75	32.5			
ATUM 33XD4 SO.. 09T306	●	33	32	44	219	132	159	60	0.5	34			
ATUM 34XD4 SO.. 09T306	●	34	32	44	223	136	163	60	0.25	34.5			
ATUM 35XD4 SO.. 120408	●	35	32	44	227	140	167	60	2.75	40.5			

R: Sağ / Right / Rechts L: Sol/Left/Links

● Stokta / In Stock / Auf Lager ○ Stokta Yok / Non Stock Item / Kein Lagerartikel, Lieferzeit auf Anfrage
ISCR Ucuna Uygunudur. / Compatible with ISCR Insert. / Kompatibel mit ISCR Wendeplatten.

Sipariş Örneği/Ordering Example/Bestellbeispiel
1 ad./pcs./stück ATUM 14XD4 SO.. 050204

Takma Uçlu Matkap Kullanım Kılavuzu : S 367 / User's Guide For U-Drills : P 367
S.368 / Bedienungsanleitung für Vollbohrer



Delme Derinliği
Drilling Depth
Bohrtiefe

= 2xÇap
= 2xDiameter
= 2xDurchmesser

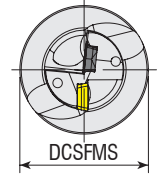
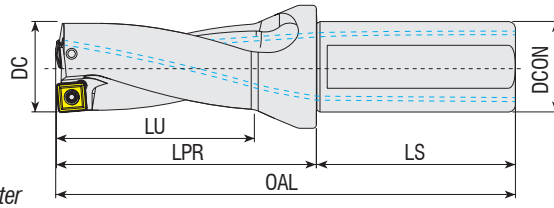

Takım Kodu
Ordering Code
Bestell-Bezeichnung

Stok
Stock
Lager

Takım Ölçüleri (mm)
Dimension (mm)
Abmessung (mm)

Maks. Ofset (radyal)
Max. Offset (radial)
Max. Versatz (radial)

Kesici Uç
Insert
Wendeschneidplatte

Yedek Parçaları / Spare Parts / Ersatzteile

Sıkma Vidası
Screw
Schraube

Tork Anahtar
Torx Key
Torx-Schlüssel

ATUM	KDR	0502..	●	DC	DCON	DCSFMS	OAL	LU	LPR	LS	X _{max}	DC _{max}	Kesici Uç Insert Wendeschneidplatte	Sıkma Vidası Screw Schraube	Tork Anahtar Torx Key Torx-Schlüssel
ATUM 14XD2	KDR 0502..	●	14	20	25	100	28	50	50	0.25	14.5	SPMT 050204-XOMT 050204	3006-M2x4	80-T06	
ATUM 18XD2	KDR 0602..	●	18	25	34	114	36	58	56	0.5	19	SPMT 060205-XOMT 060204	3007-M2.2x5	80-T07	
ATUM 20XD2	KDR 07T2..	●	20	25	34	118	40	62	56	0.3	20.6	SPMT 07T208 XOMT 07T205	3008-M2.5x6	80-T08	
ATUM 22XD2	KDR 07T2..	●	22	25	34	122	44	66	56	0.3	22.6	SPMT 090308 XOMT 090305	3008-M3x7		
ATUM 24XD2	KDR 0903..	●	24	25	34	126	48	70	56	0.3	24.6				
ATUM 25XD2	KDR 0903..	●	25	25	34	128	50	72	56	0.3	25.6				
ATUM 26XD2	KDR 0903..	●	26	25	34	130	52	74	56	0.3	26.6	SPMT 11T308 XOMT 11T306	4015-M3.5x9	80-T15	
ATUM 28XD2	KDR 0903..	●	28	25	34	134	56	78	56	0.3	28.6				
ATUM 30XD2	KDR 11T3..	●	30	25	34	147	60	87	60	0.35	30.7	SPMT 11T308 XOMT 11T306	4015-M3.5x9		
ATUM 32XD2	KDR 11T3..	●	32	32	44	151	64	91	60	0.35	32.7				
ATUM 34XD2	KDR 11T3..	●	34	32	44	155	68	95	60	0.35	34.7	SPMT 130410 - XOMT 130406	4015-M4x11		
ATUM 37XD2	KDR 1304..	●	37	32	44	161	74	101	60	0.35	37.7				

KRLY Ucuna Uygunudur. / Compatible with KRLY Insert. / Kompatibel mit KRLY Wendeplatten.



Delme Derinliği
Drilling Depth
Bohrtiefe

= 4xÇap
= 4xDiameter
= 4xDurchmesser

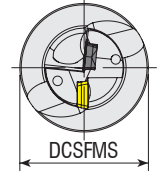
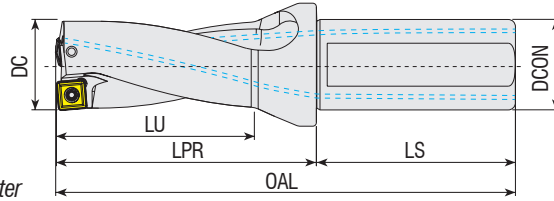

Takım Kodu
Ordering Code
Bestell-Bezeichnung

Stok
Stock
Lager

Takım Ölçüleri (mm)
Dimension (mm)
Abmessung (mm)

Maks. Ofset (radyal)
Max. Offset (radial)
Max. Versatz (radial)

Kesici Uç
Insert
Wendeschneidplatte

Yedek Parçaları / Spare Parts / Ersatzteile

Sıkma Vidası
Screw
Schraube

Tork Anahtar
Torx Key
Torx-Schlüssel

ATUM	KDR	0502..	●	DC	DCON	DCSFMS	OAL	LU	LPR	LS	X _{max}	DC _{max}	Kesici Uç Insert Wendeschneidplatte	Sıkma Vidası Screw Schraube	Tork Anahtar Torx Key Torx-Schlüssel
ATUM 14XD4	KDR 0502..	●	14	20	25	128	56	78	50	0.25	14.5	SPMT 050204 XOMT 050204	3006-M2x4	80-T06	
ATUM 14.5XD4	KDR 0502..	●	14.5	20	25	128	56	78	50	0.25	15				
ATUM 15XD4	KDR 0502..	●	15	20	25	132	60	82	50	0.25	15.5	SPMT 060205 XOMT 060204	3007-M2.2x5	80-T07	
ATUM 15.5XD4	KDR 0502..	●	15.5	20	25	132	60	82	50	0.25	16				
ATUM 16XD4	KDR 0502..	●	16	25	34	142	64	86	56	0.25	16.5	SPMT 07T208 XOMT 07T205	3008-M2.5x6	80-T08	
ATUM 17XD4	KDR 0602..	●	17	25	34	146	68	90	56	0.5	18				
ATUM 17.5XD4	KDR 0602..	●	17.5	25	34	146	68	90	56	0.5	18.5	SPMT 090308 XOMT 090305	3008-M3x7		
ATUM 18XD4	KDR 0602..	●	18	25	34	150	72	94	56	0.5	19				
ATUM 18.5XD4	KDR 0602..	●	18.5	25	34	150	72	94	56	0.5	19.5	SPMT 11T308 XOMT 11T306	4015-M3.5x9		
ATUM 19XD4	KDR 0602..	●	19	25	34	154	76	98	56	0.5	20				
ATUM 20XD4	KDR 07T2..	●	20	25	34	158	80	102	56	0.3	20.6	SPMT 130410 - XOMT 130406	4015-M4x11		
ATUM 21XD4	KDR 07T2..	●	21	25	34	162	84	106	56	0.3	21.6				
ATUM 22XD4	KDR 07T2..	●	22	25	34	166	88	110	56	0.3	22.6				
ATUM 24XD4	KDR 0903..	●	24	25	34	174	96	118	56	0.3	24.6				
ATUM 25XD4	KDR 0903..	●	25	25	34	178	100	122	56	0.3	25.6				

R: Sağ / Right / Rechts L: Sol/Left/Links

● Stokta / In Stock / Auf Lager ○ Stokta Yok / Non Stock Item / Kein Lagerartikel, Lieferzeit auf Anfrage

KRLY Ucuna Uygunudur. / Compatible with KRLY Insert. / Kompatibel mit KRLY Wendeplatten.

Sipariş Örneği/Ordering Example/Bestellbeispiel

1 ad./pcs./stück ATUM 14XD2 KDR 0502..

Takma Uçlu Matkap Kullanım Kılavuzu : S 367 / User's Guide For U-Drills : P 367 / S.368 / Bedienungsanleitung für Vollbohrer



Delme Derinliği
Drilling Depth
Bohrtiefe

= 3xÇap
= 3xDiameter
= 3xDurchmesser

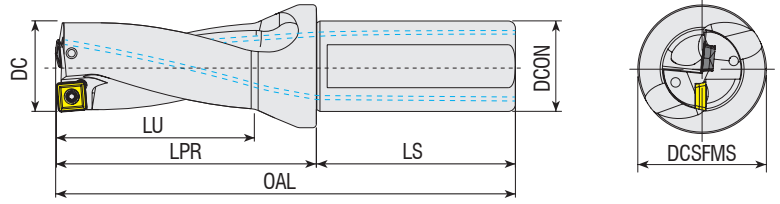

Takım Kodu Ordering Code Bestell-Bezeichnung	Stok Stock Lager	Takım Ölçüleri (mm) Dimension (mm) Abmessung (mm)								Maks. Ofset (radyal) Max. Offset (radial) Max. Versatz (radial)		Kesici Uç Insert Wendeschneidplatte	Yedek Parçaları / Spare Parts / Ersatzteile	
		DC	DCON	DCSFMS	OAL	LU	LPR	LS	X _{max} [mm]	DC _{max} [mm]	Sıkma Vidası Screw Schraube		Tork Anahtar Torx Key Torx-Schlüssel	
ATUM 12.5XD3 KDR 0402..	●	12.5	20	25	108	36	58	50	0.2	12.9	SPMT 040204 XOMT 040204	3006-M2x4	80-T06	
ATUM 13XD3 KDR 0402..	●	13	20	25	111	39	61	50	0.2	13.4				
ATUM 14XD3 KDR 0502..	●	14	20	25	114	42	64	50	0.25	14.5	SPMT 050204 XOMT 050204	3006-M2x4	80-T06	
ATUM 14.5XD3 KDR 0502..	●	14.5	20	25	114	42	64	50	0.25	15				
ATUM 15XD3 KDR 0502..	●	15	20	25	117	45	67	50	0.25	15.5	SPMT 060205 XOMT 060204	3007-M2.2x5	80-T07	
ATUM 15.5XD3 KDR 0502..	●	15.5	20	25	117	45	67	50	0.25	16				
ATUM 16XD3 KDR 0502..	●	16	25	34	126	48	70	56	0.25	16.5	SPMT 07T208 XOMT 07T205	3008-M2.5x6	80-T08	
ATUM 16.5XD3 KDR 0602..	●	16.5	25	34	126	48	70	56	0.5	17.5				
ATUM 17XD3 KDR 0602..	●	17	25	34	129	51	73	56	0.5	18	SPMT 090308 XOMT 090305	3008-M3x7	80-T15	
ATUM 17.5XD3 KDR 0602..	●	17.5	25	34	129	51	73	56	0.5	18.5				
ATUM 18XD3 KDR 0602..	●	18	25	34	132	54	76	56	0.5	19	SPMT 11T308 XOMT 11T306	4015-M3.5x9	80-T15	
ATUM 18.5XD3 KDR 0602..	●	18.5	25	34	132	54	76	56	0.5	19.5				
ATUM 19XD3 KDR 0602..	●	19	25	34	135	57	79	56	0.5	20	SPMT 130410 XOMT 130406	4015-M4x11	80-T15	
ATUM 19.5XD3 KDR 0602..	●	19.5	25	34	135	57	79	56	0.5	20.5				
ATUM 20XD3 KDR 07T2..	●	20	25	34	138	60	82	56	0.3	20.6	SPMT 11T308 XOMT 11T306	4015-M3.5x9	80-T15	
ATUM 20.5XD3 KDR 07T2..	●	20.5	25	34	138	60	82	56	0.3	21.1				
ATUM 21XD3 KDR 07T2..	●	21	25	34	141	63	85	56	0.3	21.6	SPMT 130410 XOMT 130406	4015-M4x11	80-T15	
ATUM 22XD3 KDR 07T2..	●	22	25	34	144	66	88	56	0.3	22.6				
ATUM 23XD3 KDR 07T2..	●	23	25	34	147	69	91	56	0.3	23.6	SPMT 130410 XOMT 130406	4015-M4x11	80-T15	
ATUM 23.5XD3 KDR 07T2..	●	23.5	25	34	147	69	91	56	0.3	24.1				
ATUM 24XD3 KDR 0903..	●	24	25	34	150	72	94	56	0.3	24.6	SPMT 130410 XOMT 130406	4015-M4x11	80-T15	
ATUM 24.5XD3 KDR 0903..	●	24.5	25	34	150	72	94	56	0.3	25.1				
ATUM 25XD3 KDR 0903..	●	25	25	34	153	75	97	56	0.3	25.6	SPMT 130410 XOMT 130406	4015-M4x11	80-T15	
ATUM 26XD3 KDR 0903..	●	26	25	34	156	78	100	56	0.3	26.6				
ATUM 27XD3 KDR 0903..	●	27	25	34	159	81	103	56	0.3	27.6	SPMT 130410 XOMT 130406	4015-M4x11	80-T15	
ATUM 28XD3 KDR 0903..	●	28	25	34	162	84	106	56	0.3	28.6				
ATUM 29XD3 KDR 0903..	●	29	25	34	165	87	109	56	0.3	29.6	SPMT 130410 XOMT 130406	4015-M4x11	80-T15	
ATUM 30XD3 KDR 11T3..	●	30	32	44	177	90	117	60	0.35	30.7				
ATUM 32XD3 KDR 11T3..	●	32	32	44	183	96	123	60	0.35	32.7	SPMT 130410 XOMT 130406	4015-M4x11	80-T15	
ATUM 33XD3 KDR 11T3..	●	33	32	44	186	99	126	60	0.35	33.7				
ATUM 34XD3 KDR 11T3..	●	34	32	44	189	102	129	60	0.35	34.7	SPMT 130410 XOMT 130406	4015-M4x11	80-T15	
ATUM 35XD3 KDR 11T3..	●	35	32	44	192	105	132	60	0.35	35.7				
ATUM 37XD3 KDR 1304..	●	37	32	44	198	111	138	60	0.35	37.7	SPMT 130410 XOMT 130406	4015-M4x11	80-T15	
ATUM 38XD3 KDR 1304..	●	38	32	44	201	114	141	60	0.35	38.7				
ATUM 39XD3 KDR 1304..	●	39	32	44	204	117	144	60	0.35	39.7	SPMT 130410 XOMT 130406	4015-M4x11	80-T15	
ATUM 40XD3 KDR 1304..	●	40	32	44	207	120	147	60	0.35	40.7				

R: Sağ / Right / Rechts L: Sol/Left/Links

● Stokta / In Stock / Auf Lager ○ Stokta Yok / Non Stock Item / Kein Lagerartikel, Lieferzeit auf Anfrage
KRLY Ucuna Uygunudur. / Compatible with KRLY Insert. / Kompatibel mit KRLY Wendepplatten.

Sipariş Örneği/Ordering Example/Bestellbeispiel

1 ad./pcs./stück ATUM 12.5XD3 KDR 0402..

Takma Uçlu Matkap Kullanım Kılavuzu : S 367 / User's Guide For U-Drills : P 367
S.368 / Bedienungsanleitung für Vollbohrer



Delme Derinliği
Drilling Depth
Bohrtiefe

= 2xÇap
= 2xDiameter
= 2xDurchmesser

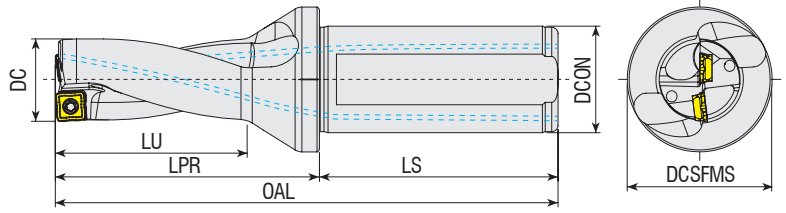

Takım Kodu
Ordering Code
Bestell-Bezeichnung

Stok
Stock
Lager

Takım Ölçüleri (mm)
Dimension (mm)
Abmessung (mm)

Maks. Ofset (radyal)
Max. Offset (radial)
Max. Versatz (radial)

Kesici Uç
Insert
Wendeschneidplatte

Yedek Parçaları / Spare Parts / Ersatzteile

Sıkma Vidası
Screw
Schraube

Tork Anahtar
Torx Key
Torx-Schlüssel

●

DC

DCON

DCSFMS

OAL

LU

LPR

LS

X_{max}

DC_{max}

●

DC

DCON

DCSFMS

OAL

LU

LPR

LS

0.5

15

●

SOMT 050204

3006-M2x4

80-T06

●

DC

DCON

DCSFMS

OAL

LU

LPR

LS

0.5

18

●

SOMT 060204

3007-M2.2x5

80-T07

●

DC

DCON

DCSFMS

OAL

LU

LPR

LS

0.5

21

●

SOMT 070306

3008-M2.5x6

80-T08

●

DC

DCON

DCSFMS

OAL

LU

LPR

LS

0.5

25

●

SOMT 08T306

4015-M3.5x9

80-T15

●

DC

DCON

DCSFMS

OAL

LU

LPR

LS

0.5

28

●

SOMT 09T308

4015-M4x11

80-T15

●

DC

DCON

DCSFMS

OAL

LU

LPR

LS

0.5

29

●

SOMT 09T308

4015-M4x11

80-T15

●

DC

DCON

DCSFMS

OAL

LU

LPR

LS

0.5

30

●

SOMT 11T308

4015-M4x11

80-T15

●

DC

DCON

DCSFMS

OAL

LU

LPR

LS

0.5

31

●

SOMT 11T308

4015-M4x11

80-T15

●

DC

DCON

DCSFMS

OAL

LU

LPR

LS

0.5

33

●

SOMT 130408

4015-M4x11

80-T15

●

DC

DCON

DCSFMS

OAL

LU

LPR

LS

0.5

34

●

SOMT 130408

4015-M4x11

80-T15

●

DC

DCON

DCSFMS

OAL

LU

LPR

LS

0.5

35

●

SOMT 130408

4015-M4x11

80-T15

●

DC

DCON

DCSFMS

OAL

LU

LPR

LS

0.5

36

●

SOMT 150510

1020-M5x11

80-T20

●

DC

DCON

DCSFMS

OAL

LU

LPR

LS

0.5

46

●

SOMT 150510

1020-M5x11

80-T20

R: Sağ / Right / Rechts L: Sol/Left/Links

● Stokta / In Stock / Auf Lager ○ Stokta Yok / Non Stock Item / Kein Lagerartikel, Lieferzeit auf Anfrage
TGTC Ucuna Uygundur. / Compatible with TGTC Insert. / Kompatibel mit TGTC Wendeplatten.

Sipariş Örneği/Ordering Example/Bestellbeispiel

1 ad./pcs./stück ATUM 14XD2 SOMT 050204

Takma Uçlu Matkap Kullanım Kılavuzu : S 367 / User's Guide For U-Drills : P 367

S.368 / Bedienungsanleitung für Vollbohrer



Delme Derinliği
Drilling Depth
Bohrtiefe

= 3xÇap
= 3xDiameter
= 3xDurchmesser

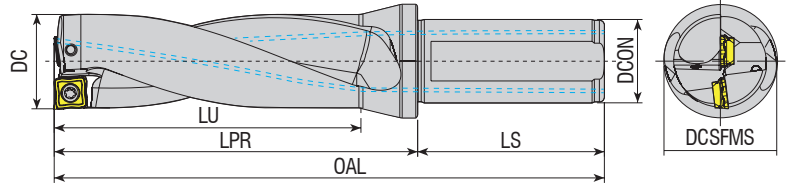

Takım Kodu
Ordering Code
Bestell-Bezeichnung

Stok
Stock
Lager

Takım Ölçüleri (mm)
Dimension (mm)
Abmessung (mm)

Maks. Ofset (radyal)
Max. Offset (radial)
Max. Versatz (radial)

Kesici Uç
Insert
Wendeschneidplatte

Yedek Parçaları / Spare Parts / Ersatzteile

Sıkma Vidası
Screw
Schraube

Tork Anahtar
Torx Key
Torx-Schlüssel

Takım Kodu Ordering Code Bestell-Bezeichnung	Stok Stock Lager	DC	DCON	DCSFMS	OAL	LU	LPR	LS	Maks. Ofset (radyal) Max. Offset (radial) Max. Versatz (radial)		Kesici Uç Insert Wendeschneidplatte	Sıkma Vidası Screw Schraube	Tork Anahtar Torx Key Torx-Schlüssel
									X _{max} [mm]	DC _{max} [mm]			
ATUM 14XD3 SOMT 050204	●	14	20	25	114	42	64	50	0.5	15	SOMT 050204	3006-M2x4	80-T06
ATUM 14.5XD3 SOMT 050204	●	14.5	20	25	114	42	64	50	0.4	15.3			
ATUM 15XD3 SOMT 050204	●	15	20	25	117	45	67	50	0.4	15.8			
ATUM 15.5XD3 SOMT 050204	●	15.5	20	25	117	45	67	50	0.3	16.1			
ATUM 16XD3 SOMT 050204	●	16	25	34	126	48	70	56	0.3	16.6	SOMT 060204	3007-M2.2x5	80-T07
ATUM 16.5XD3 SOMT 060204	●	16.5	25	34	126	48	70	56	0.5	17.5			
ATUM 17XD3 SOMT 060204	●	17	25	34	129	51	73	56	0.5	18			
ATUM 17.5XD3 SOMT 060204	●	17.5	25	34	129	51	73	56	0.4	18.3			
ATUM 18XD3 SOMT 060204	●	18	25	34	132	54	76	56	0.4	18.8	SOMT 070306	3008-M2.5x6	80-T08
ATUM 18.5XD3 SOMT 060204	●	18.5	25	34	132	54	76	56	0.3	19.1			
ATUM 19XD3 SOMT 060204	●	19	25	34	135	57	79	56	0.3	19.6			
ATUM 19.5XD3 SOMT 070306	●	19.5	25	34	135	57	79	56	0.5	20.5			
ATUM 20XD3 SOMT 070306	●	20	25	34	138	60	82	56	0.5	21	SOMT 08T306	4015-M3.5x9	80-T15
ATUM 20.5XD3 SOMT 070306	●	20.5	25	34	138	60	82	56	0.4	21.3			
ATUM 21XD3 SOMT 070306	●	21	25	34	141	63	85	56	0.4	21.8			
ATUM 22XD3 SOMT 070306	●	22	25	34	144	66	88	56	0.3	22.6			
ATUM 22.5XD3 SOMT 08T306	●	22.5	25	34	144	66	88	56	0.5	23.5	SOMT 09T308	4015-M4x11	80-T20
ATUM 23XD3 SOMT 08T306	●	23	25	34	147	69	91	56	0.5	24			
ATUM 23.5XD3 SOMT 08T306	●	23.5	25	34	147	69	91	56	0.5	24.5			
ATUM 24XD3 SOMT 08T306	●	24	25	34	150	72	94	56	0.5	25			
ATUM 24.5XD3 SOMT 08T306	●	24.5	25	34	150	72	94	56	0.4	25.3	SOMT 11T308	1020-M5x11	80-T20
ATUM 25XD3 SOMT 08T306	●	25	25	34	153	75	97	56	0.4	25.8			
ATUM 26XD3 SOMT 08T306	●	26	25	34	156	78	100	56	0.3	26.6			
ATUM 27XD3 SOMT 09T308	●	27	25	34	159	81	103	56	0.5	28			
ATUM 27.5XD3 SOMT 09T308	●	27.5	25	34	159	81	103	56	0.5	27.5	SOMT 130408	1020-M5x11	80-T20
ATUM 28XD3 SOMT 09T308	●	28	25	34	162	84	106	56	0.5	29			
ATUM 29XD3 SOMT 09T308	●	29	25	34	165	87	109	56	0.5	30			
ATUM 30XD3 SOMT 09T308	●	30	32	44	177	90	117	60	0.5	31			
ATUM 32XD3 SOMT 11T308	●	32	32	44	183	96	123	60	0.5	33	SOMT 150510	1020-M5x11	80-T20
ATUM 33XD3 SOMT 11T308	●	33	32	44	186	99	126	60	0.5	34			
ATUM 34XD3 SOMT 11T308	●	34	32	44	189	102	129	60	0.5	35			
ATUM 35XD3 SOMT 11T308	●	35	32	44	192	105	132	60	0.5	36			
ATUM 36XD3 SOMT 11T308	●	36	32	44	195	108	135	60	0.4	36.8	SOMT 150510	1020-M5x11	80-T20
ATUM 37XD3 SOMT 130408	●	37	32	44	198	111	138	60	0.5	38			
ATUM 38XD3 SOMT 130408	●	38	32	44	201	114	141	60	0.5	39			
ATUM 39XD3 SOMT 130408	●	39	32	44	204	117	144	60	0.5	40			
ATUM 40XD3 SOMT 130408	●	40	32	44	207	120	147	60	0.5	41	SOMT 150510	1020-M5x11	80-T20
ATUM 45XD3 SOMT 150510	●	45	40	54	237	135	167	70	0.5	46			
ATUM 49XD3 SOMT 150510	●	49	40	54	249	147	179	70	0.5	50			
ATUM 50XD3 SOMT 150510	●	50	40	54	252	150	182	70	0.5	51			

R: Sağ / Right / Rechts L: Sol/Left/Links

● Stokta / In Stock / Auf Lager ○ Stokta Yok / Non Stock Item / Kein Lagerartikel, Lieferzeit auf Anfrage

TGTC Ucuna Uygunudur. / Compatiple with TGTC Insert. / Kompatibel mit TGTC Wendepplatten.

Sipariş Örneği/Ordering Example/Bestellbeispiel

1 ad./pcs./stück ATUM 14XD3 SOMT 050204

Takma Uçlu Matkap Kullanım Kılavuzu : S 367 / User's Guide For U-Drills : P 367

S.368 / Bedienungsanleitung für Vollbohrer



Delme Derinliği
Drilling Depth
Bohrtiefe

= 4xÇap
= 4xDiameter
= 4xDurchmesser

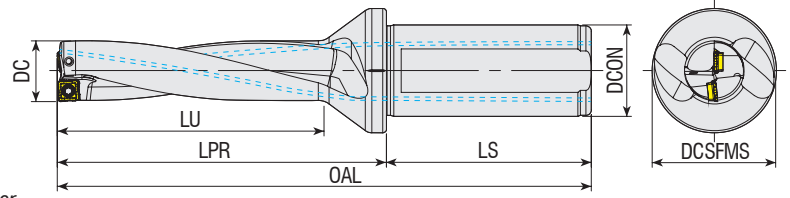

Takım Kodu
Ordering Code
Bestell-Bezeichnung

Takım Kodu Ordering Code Bestell-Bezeichnung	Stok Stock Lager	Takım Ölçüleri (mm) Dimension (mm) Abmessung (mm)							Maks. Ofset (radyal) Max. Offset (radial) Max. Versatz (radial)		Kesici Uç Insert Wendeschneidplatte	Yedek Parçaları / Spare Parts / Ersatzteile	
		DC	DCON	DCSFMS	OAL	LU	LPR	LS	X _{max}	DC _{max}		Sıkma Vidası Screw Schraube	Tork Anahtar Torx Key Torx-Schlüssel
ATUM 14XD4 SOMT 050204	●	14	20	25	128	56	78	50	0.5	15	SOMT 050204	3006-M2x4	80-T06
ATUM 14.5XD4 SOMT 050204	●	14.5	20	25	128	56	78	50	0.4	15.3			
ATUM 16XD4 SOMT 050204	●	16	25	34	142	64	86	56	0.3	16.6	SOMT 060204	3007-M2.2x5	80-T07
ATUM 17XD4 SOMT 060204	●	17	25	34	146	68	90	56	0.5	18			
ATUM 17.5XD4 SOMT 060204	●	17.5	25	34	146	68	90	56	0.4	18.3	SOMT 060204	3007-M2.2x5	80-T07
ATUM 18XD4 SOMT 060204	●	18	25	34	150	72	94	56	0.4	18.8			
ATUM 19XD4 SOMT 060204	●	19	25	34	154	76	98	56	0.3	19.6	SOMT 070306	3008-M2.5x6	80-T08
ATUM 20XD4 SOMT 070306	●	20	25	34	158	80	102	56	0.5	21			
ATUM 21XD4 SOMT 070306	●	21	25	34	162	84	106	56	0.4	21.8	SOMT 070306	3008-M2.5x6	80-T08
ATUM 22XD4 SOMT 070306	●	22	25	34	166	88	110	56	0.3	22.6			
ATUM 24XD4 SOMT 08T306	●	24	25	34	174	96	118	56	0.5	25	SOMT 08T306	3008-M2.5x6	80-T08
ATUM 25XD4 SOMT 08T306	●	25	25	34	178	100	122	56	0.4	25.8			

R: Sağ / Right / Rechts L: Sol/Left/Links
● Stokta / In Stock / Auf Lager ○ Stokta Yok / Non Stock Item / Kein Lagerartikel, Lieferzeit auf Anfrage
TGTC Ucuna Uygundur. / Compatible with TGTC Insert. / Kompatibel mit TGTC Wendepplatten.

Sipariş Örneği/Ordering Example/Bestellbeispiel
1 ad./pcs./stück ATUM ATUM 14XD4 SOMT 050204
Takma Uçlu Matkap Kullanım Kılavuzu : S 367 / User's Guide For U-Drills : P 367
S.368 / Bedienungsanleitung für Vollbohrer





Delme Derinliği
Drilling Depth
Bohrtiefe = 5xÇap
= 5xDiameter
= 5xDurchmesser

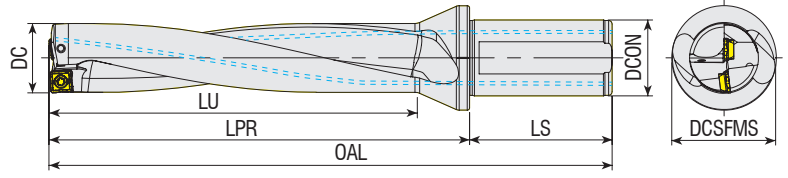

Takım Kodu Ordering Code Bestell-Bezeichnung	Stok Stock Lager	Takım Ölçüleri (mm) Dimension (mm) Abmessung (mm)							Maks. Ofset (radyal) Max. Offset (radial) Max. Versatz (radial)		Kesici Uç Insert Wendeschneidplatte	Yedek Parçaları / Spare Parts / Ersatzteile	
		DC	DCON	DCSFMS	OAL	LU	LPR	LS	X _{max} [mm]	DC _{max} [mm]		Sıkma Vidası Screw Schraube	Tork Anahtar Torx Key Torx-Schlüssel
ATUM 14XD5 SOMT 050204	●	14	20	25	142	70	92	50	0.5	15	SOMT 050204	3006-M2x4	80-T06
ATUM 15XD5 SOMT 050204	●	15	20	25	147	75	97	50	0.4	15.8			
ATUM 15.5XD5 SOMT 050204	●	15.5	20	25	147	75	97	50	0.3	16.1			
ATUM 16XD5 SOMT 050204	●	16	25	34	158	80	102	56	0.3	16.6	SOMT 060204	3007-M2.2x5	80-T07
ATUM 16.5XD5 SOMT 060204	●	16.5	25	34	158	80	102	56	0.5	17.5			
ATUM 17.5XD5 SOMT 060204	●	17.5	25	34	163	85	107	56	0.4	18.3			
ATUM 18XD5 SOMT 060204	●	18	25	34	168	90	112	56	0.4	18.8	SOMT 070306	3008-M2.5x6	80-T08
ATUM 18.5XD5 SOMT 060204	●	18.5	25	34	168	90	112	56	0.3	19.1			
ATUM 19XD5 SOMT 060204	●	19	25	34	173	95	117	56	0.3	19.6			
ATUM 19.5XD5 SOMT 070306	●	19.5	25	34	173	95	117	56	0.5	20.5	SOMT 08T306	4015-M3.5x9	80-T15
ATUM 20XD5 SOMT 070306	●	20	25	34	178	100	122	56	0.5	21			
ATUM 21XD5 SOMT 070306	●	21	25	34	183	105	127	56	0.4	21.8			
ATUM 22XD5 SOMT 070306	●	22	25	34	188	110	132	56	0.3	22.6	SOMT 09T308	4015-M3.5x9	80-T15
ATUM 23XD5 SOMT 08T306	●	23	25	34	193	115	137	56	0.5	24			
ATUM 24XD5 SOMT 08T306	●	24	25	34	198	120	142	56	0.5	25			
ATUM 25XD5 SOMT 08T306	●	25	25	34	203	125	147	56	0.4	25.8	SOMT 11T308	4015-M3.5x9	80-T15
ATUM 26XD5 SOMT 08T306	●	26	25	34	208	130	152	56	0.3	26.6			
ATUM 27XD5 SOMT 09T308	●	27	25	34	213	135	157	56	0.5	28			
ATUM 28XD5 SOMT 09T308	●	28	25	34	218	140	162	56	0.5	29	SOMT 11T308	4015-M3.5x9	80-T15
ATUM 29XD5 SOMT 09T308	●	29	25	34	223	145	167	56	0.5	30			
ATUM 30XD5 SOMT 09T308	●	30	32	44	237	150	177	60	0.5	31			
ATUM 33XD5 SOMT 11T308	●	33	32	44	252	165	192	60	0.5	34	SOMT 11T308	4015-M3.5x9	80-T15
ATUM 34XD5 SOMT 11T308	●	34	32	44	257	170	197	60	0.5	35			
ATUM 35XD5 SOMT 11T308	●	35	32	44	262	175	202	60	0.5	36			
ATUM 36XD5 SOMT 11T308	●	36	32	44	267	180	207	60	0.4	36.8			

R: Sağ / Right / Rechts L: Sol/Left/Links

● Stokta / In Stock / Auf Lager ○ Stokta Yok / Non Stock Item / Kein Lagerartikel, Lieferzeit auf Anfrage

TGTC Ucuna Uygundur. / Compatible with TGTC Insert. / Kompatibel mit TGTC Wendepplatten.

Sipariş Örneği/Ordering Example/Bestellbeispiel

1 ad./pcs./stück ATUM 14XD5 SOMT 050204

Takma Uçlu Matkap Kullanım Kılavuzu : S 367 / User's Guide For U-Drills : P 367
S.368 / Bedienungsanleitung für Vollbohrer



Delme Derinliği
Drilling Depth
Bohrtiefe = 3xÇap
= 3xDiameter
= 3xDurchmesser

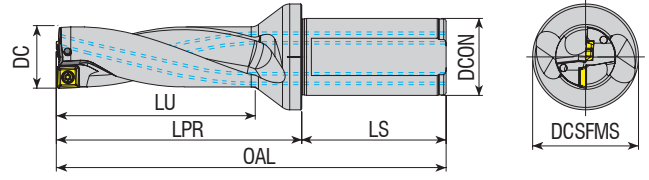

Takım Kodu
Ordering Code
Bestell-Bezeichnung

Stok
Stock
Lager

Takım Ölçüleri (mm)
Dimension (mm)
Abmessung (mm)

Maks. Ofset (radyal)
Max. Offset (radial)
Max. Versatz (radial)

Kesici Uç
Insert
Wendeschneidplatte

Yedek Parçaları / Spare Parts / Ersatzteile

Sıkma Vidası
Screw
Schraube

Tork Anahtar
Torx Key
Torx-Schlüssel

DC

DCON

DCSFMS

OAL

LU

LPR

LS

X_{max}
X_{max}[mm] DC_{max}[mm]

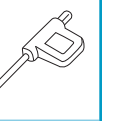

Takım Kodu Ordering Code Bestell-Bezeichnung	Stok Stock Lager	DC	DCON	DCSFMS	OAL	LU	LPR	LS	Maks. Ofset (radyal) Max. Offset (radial) Max. Versatz (radial)	X _{max} X _{max} [mm] DC _{max} [mm]	Kesici Uç Insert Wendeschneidplatte	Sıkma Vidası Screw Schraube	Tork Anahtar Torx Key Torx-Schlüssel
ATUM 14XD3 880-0202..	●	14	20	25	108	42	58	50	0.5	15	880-02...C/P	3006-M2x4	80-T06
ATUM 14.5XD3 880-0202..	●	14.5	20	25	110	46	60	50	0.45	15.4			
ATUM 15XD3 880-0202..	●	15	20	25	112	48	62	50	0.4	15.8			
ATUM 15.5XD3 880-0202..	●	15.5	20	25	114	50	64	50	0.3	16.1			
ATUM 16XD3 880-0202..	●	16	20	25	116	51	66	50	0.3	16.6			
ATUM 16.5XD3 880-0303..	●	16.5	20	25	118	53	68	50	0.6	17.7	880-03...C/P	3007-M2.2x5	80-T07
ATUM 17XD3 880-0303..	●	17	20	25	119	54	69	50	0.6	18.2			
ATUM 17.5XD3 880-0303..	●	17.5	25	32	128	56	72	56	0.5	18.5			
ATUM 18XD3 880-0303..	●	18	25	32	129	57	73	56	0.4	18.8			
ATUM 18.5XD3 880-0303..	●	18.5	25	32	131	59	75	56	0.4	19.3			
ATUM 19XD3 880-0303..	●	19	25	32	132	60	76	56	0.3	19.6	880-04...C/P	3008-M2.5x6	80-T08
ATUM 19.5XD3 880-0303..	●	19.5	25	32	135	62	79	56	0.3	20.1			
ATUM 20XD3 880-0403..	●	20	25	32	137	64	81	56	0.9	21.8			
ATUM 20.5XD3 880-0403..	●	20.5	25	32	138	65	82	56	0.8	22.1			
ATUM 21XD3 880-0403..	●	21	25	32	140	66	84	56	0.8	22.6			
ATUM 21.5XD3 880-0403..	●	21.5	25	32	142	68	86	56	0.7	22.9	880-05...C/P	4010-M3x8	80-T10
ATUM 22XD3 880-0403..	●	22	25	32	143	69	87	56	0.6	23.2			
ATUM 22.5XD3 880-0403..	●	22.5	25	32	146	71	90	56	0.5	23.5			
ATUM 23XD3 880-0403..	●	23	25	32	147	72	91	56	0.5	24			
ATUM 24XD3 880-0503..	●	24	25	32	151	76	95	56	1.1	26.2			
ATUM 25XD3 880-0503..	●	25	25	32	155	79	99	56	1	27	880-06...C/P	3010-M3.5x9	80-T10
ATUM 26XD3 880-0503..	●	26	32	44	162	81	102	60	0.9	27.8			
ATUM 27XD3 880-0503..	●	27	32	44	165	84	105	60	0.7	28.4			
ATUM 28XD3 880-0503..	●	28	32	44	169	87	109	60	0.6	29.2			
ATUM 29XD3 880-0503..	●	29	32	44	172	90	112	60	0.5	30			
ATUM 30XD3 880-0604..	●	30	32	44	177	94	117	60	1.1	32.2	880-07...C/P	3010-M3.5x9	80-T15
ATUM 31XD3 880-0604..	●	31	40	54	191	97	121	70	1	33			
ATUM 32XD3 880-0604..	●	32	40	54	194	100	124	70	0.9	33.8			
ATUM 33XD3 880-0604..	●	33	40	54	198	103	128	70	0.7	34.4			
ATUM 34XD3 880-0604..	●	34	40	54	201	106	131	70	0.5	35			
ATUM 35XD3 880-0604..	●	35	40	54	205	109	135	70	0.4	35.8	880-08...C/P	4015-M4x11	80-T15
ATUM 36XD3 880-0704..	●	36	40	54	209	112	139	70	1.3	38.6			
ATUM 38XD3 880-0704..	●	38	40	54	216	118	146	70	1.1	40.2			
ATUM 39XD3 880-0704..	●	39	40	54	219	121	149	70	1	41			
ATUM 40XD3 880-0704..	●	40	40	54	223	124	153	70	0.8	41.6			
ATUM 41XD3 880-0704..	●	41	40	54	227	127	157	70	0.7	42.4	880-08...C/P	4015-M4x11	80-T15
ATUM 42XD3 880-0704..	●	42	40	54	230	130	160	70	0.6	43.2			
ATUM 45XD3 880-0805..	●	45	40	54	242	140	172	70	1.4	47.8			
ATUM 46XD3 880-0805..	●	46	40	54	246	143	176	70	1.3	48.6			
ATUM 48XD3 880-0805..	●	48	40	54	253	149	183	70	1	50			
ATUM 50XD3 880-0805..	●	50	40	54	260	155	190	70	0.8	51.6			

R: Sağ / Right / Rechts L: Sol/Left/Links

● Stokta / In Stock / Auf Lager ○ Stokta Yok / Non Stock Item / Kein Lagerartikel, Lieferzeit auf Anfrage
SNDVK Ucuna Uygunudur. / Compatible with SNDVK Insert. / Kompatibel mit SNDVK Wendepalten.

Sipariş Örneği/Ordering Example/Bestellbeispiel

1 ad./pcs./stück ATUM 14XD3 880-0202..

Takma Uçlu Matkap Kullanım Kılavuzu : S 367 / User's Guide For U-Drills : P 367
S.368 / Bedienungsanleitung für Vollbohrer

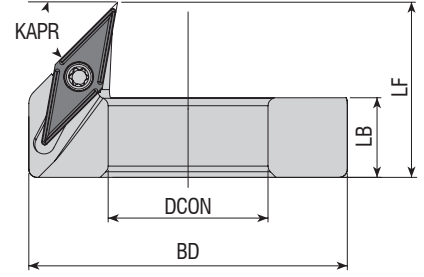

Takım Kodu Ordering Code Bestell-Bezeichnung	Stok Stock Lager	Takım Ölçüleri (mm) Dimension (mm) Abmessung (mm)				Kullanılacak ATUM Ölçüsü Compatible ATUM Diameter Verwendeter Vollbohrer	Yedek Parçaları / Spare Parts / Ersatzteile				
		BD	DCON	LB	LF		ATUM Ø	Kesici Uç Insert Wendeschneidplatte	Sıkma Vidası Screw Schraube	Tork Anahtar Torx Key Torx-Schlüssel	Montaj Vidası Mounting Screw Befestigungsschraube
ADCR-120-VB1103	●	32	12	10	22	12.5					
ADCR-125-VB1103	●	32.5	12.5	10	22	13					
ADCR-130-VB1103	●	33	13	10	22	13.5					
ADCR-135-VB1103	●	33.5	13.5	10	22	14					
ADCR-140-VB1103	●	34	14	10	22	14.5					
ADCR-145-VB1103	●	34.5	14.5	10	22	15					
ADCR-150-VB1103	●	35	15	10	22	15.5 -16					
ADCR-155-VB1103	●	35.5	15.5	10	22	16.5					
ADCR-160-VB1103	●	36	16	10	22	17					
ADCR-165-VB1103	●	36.5	16.5	10	22	17.5					
ADCR-170-VB1103	●	37	17	10	22	18					
ADCR-175-VB1103	●	37.5	17.5	10	22	18.5					
ADCR-180-VB1103	●	38	18	10	22	19					
ADCR-185-VB1103	●	38.5	18.5	10	22	19.5					
ADCR-190-VB1103	●	39	19	10	22	20					
ADCR-195-VB1103	●	39.5	19.5	10	22	20.5					
ADCR-200-VB1103	●	40	20	10	22	21					
ADCR-205-VB1103	●	40.5	20.5	10	22	21.5					
ADCR-210-VB1103	●	41	21	10	22	22	VBM. 1103..	4008-M2.5x6	80-T08	AAV-14-M5x14	AAL-03-3
ADCR-215-VB1103	●	41.5	21.5	10	22	22.5					
ADCR-220-VB1103	●	42	22	10	22	23					
ADCR-225-VB1103	●	42.5	22.5	10	22	23.5					
ADCR-230-VB1103	●	43	23	10	22	24					
ADCR-235-VB1103	●	43.5	23.5	10	22	24.5					
ADCR-240-VB1103	●	44	24	10	22	25					
ADCR-245-VB1103	●	44.5	24.5	10	22	25.5					
ADCR-250-VB1103	●	45	25	10	22	26					
ADCR-255-VB1103	●	45.5	25.5	10	22	26.5					
ADCR-260-VB1103	●	46	26	10	22	27					
ADCR-265-VB1103	●	46.5	26.5	10	22	27.5					
ADCR-270-VB1103	●	47	27	10	22	28					
ADCR-275-VB1103	●	47.5	27.5	10	22	28.5					
ADCR-280-VB1103	●	48	28	10	22	29					
ADCR-285-VB1103	●	48.5	28.5	10	22	29.5					
ADCR-290-VB1103	●	49	29	10	22	30					
ADCR-295-VB1103	●	49.5	29.5	10	22	30.5					
ADCR-300-VB1103	●	50	30	10	22	31					

R: Sağ / Right / Rechts L: Sol/Left/Links

● Stokta / In Stock / Auf Lager ○ Stokta Yok / Non Stock Item / Kein Lagerartikel, Lieferzeit auf Anfrage
ISO Ucuna Uygundur. / Compatible with ISO Insert. / Kompatibel mit ISO Wendepatten.

Sipariş Örneği/Ordering Example/Bestellbeispiel

1 ad./pcs./stück ADCR-120-VB1103

Takma Uçlu Matkap Kullanım Kılavuzu : S 367 / User's Guide For U-Drills : P 367

S.368 / Bedienungsanleitung für Vollbohrer



Tavsiye Edilen / Recommended / Empfehlung

A

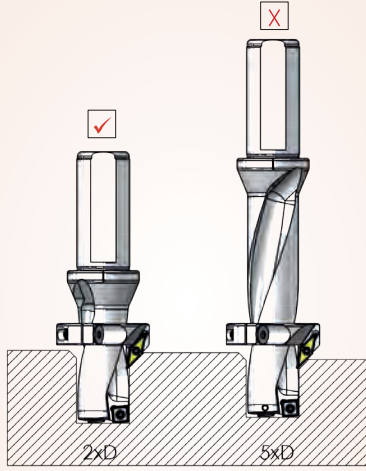

Mümkünse, her zaman kısa bir delme takımı kullanın. Değilse, titreşimi en aza indirmek için kesme hızını azaltın.
If possible, use it always short drilling tools. Otherwise, reduce your speeds to minimize vibration.
Bitte möglichst kurze Bohrwerkzeuge verwenden. Sollte dies nicht möglich sein, reduzieren Sie den Geschwindigkeit, um Vibrationen zu vermeiden.

B

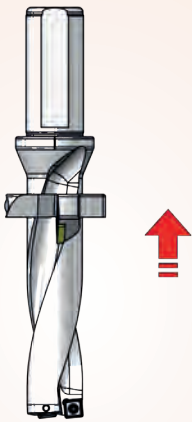

Mümkün olduğunca pah kırma halkasını shaft kısmına yakın montaj yap.
Get close to the mounting shaft of the chamfering ring as possible.
Befestigen Sie den Fasring möglichst nah am Schaft.

C

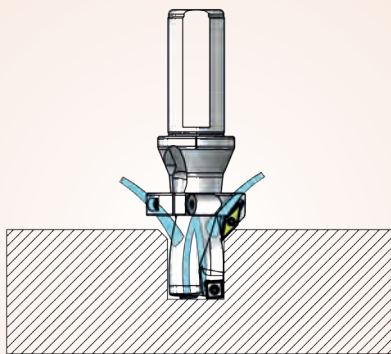

Daha iyi uç ömrü için harici soğutucu ve matkap ucu iç soğutucu uygulamak.
Apply external cooling and internal coolant drill for a better life for inserts.
Setzen Sie innere und äußere Kühlung ein, um die Standzeit der Wendeplatten zu erhöhen.

Montaj Şekli / Mounting System / Montage-Hinweise

1



Matkap gövdesi üzerine pah kırma halkasını takın.
Put the chamfering ring to drill body.
Schieben Sie den Fasring auf den Bohrkörper.

2

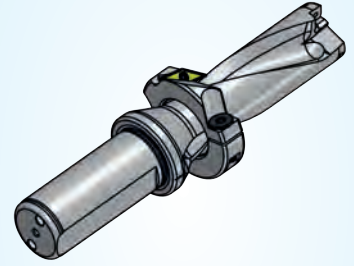

İstenilen konuma pah kırma halkasını kaydırın.
Please slide chamfering ring to the desired position.
Befestigen Sie den Fasring an der gewünschten Position.

3

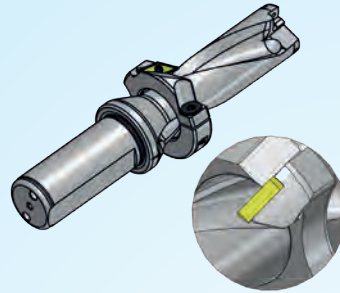

Pah kırma halkasını talaş akışına mani olmayacak şekilde helis başlangıcına denk getirin.
Please keep chamfering ring position which will not resist to fluiding chips and try to be equal to the helix start points.
Positionieren Sie den Fasring bündig mit der Bohrerspirale um einen problemlosen Späne transport zu gewährleisten.

4

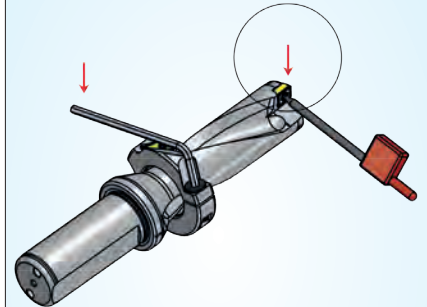

Pah kırma halkasını sıkın ve matkap uçlarını takın.
Tightening the chamfering ring and put the drill insert.
Den Fasring festziehen und die Bohr-Wendeplatten einbauen.

Pah kırma halkasının doğru montaj şekli.
Proper installation of chamfering rings.
Korrekte Montage des Fasrings.

✓

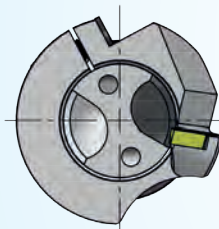

✗

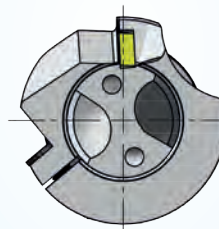

✗

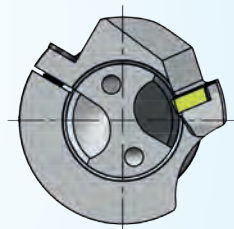

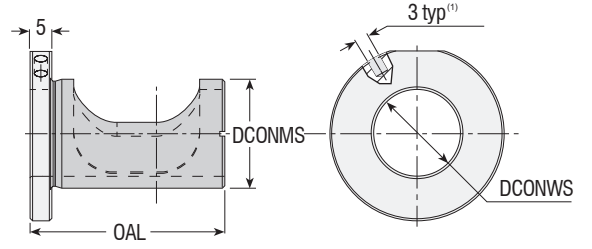

Takım Kodu Ordering Code Bestell-Bezeichnung	Stok Stock Lager	Takım Ölçüleri (mm) Dimension (mm) Abmessung (mm)		
		DCON	BD	LF
AET-2025	●	20	25	44
AET-2532	●	25	32	46
AET-3240	●	32	40	55

■⁽¹⁾ Delik ince bir metal yardımıyla adaptörün radyal olarak ayarlanmasını kolaylaştırmak için kullanılır. / Holes for inserting a pin, used to facilitate radial adjustment of the sleeve (pin not supplied).
 Bohrung zum Einsetzen eines Stiftes mit dem der Adapter radial eingestellt werden kann (Stift ist nicht im Lieferumfang enthalten).

Frezeleme tezgahında takma uçlu matkabın nominal çapı, matkabın ekseninin, spindle eksenine göre ötelenmesiyle değiştirilebilir.
 On a milling machine the drill's nominal diameter can be changed by shifting the drill's axis out of the tool spindle.

Auf einer Fräsmaschine kann die Nennweite des Bohrers durch Verschieben der Bohrerachse aus der Spindelachse verändert werden.

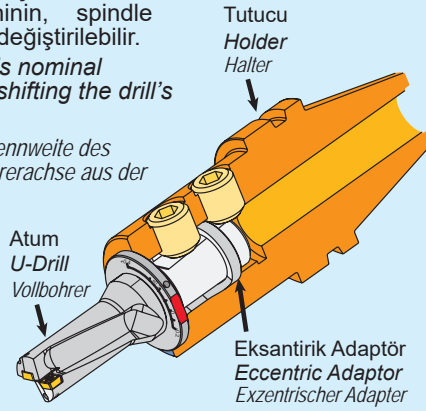

Radyal ayarlama pimi.
(Verilmeyecektir.)
 Radial adjustment pin.
(not supplied)
 Radial - Einstellstift
(nicht im Lieferumfang)

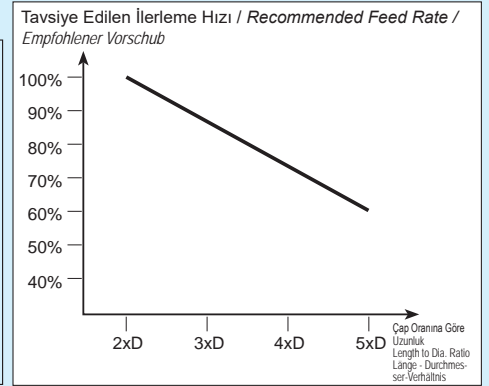
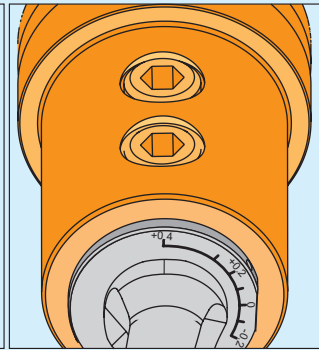
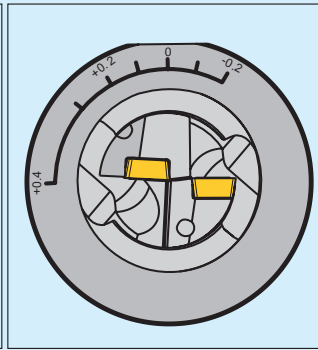
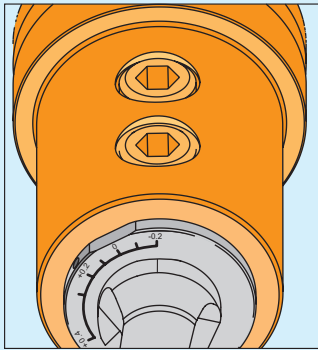
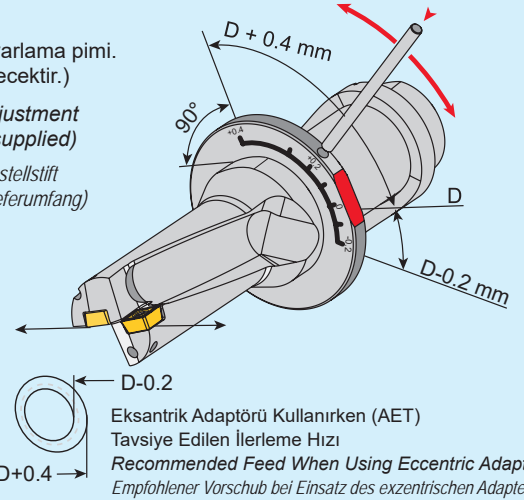

Delik Çapı
24.8 mm
Hole Diameter
Lochdurchmesser

U-Drill Çapı = 25 mm
Drill Diameter = 25 mm
Vollbohrer Durchmesser = 25 mm

Delik Çapı
25 mm
Hole Diameter
Lochdurchmesser

U-Drill Çapı = 25 mm
Drill Diameter = 25 mm
Vollbohrer Durchmesser = 25 mm

Delik Çapı
25.4 mm
Hole Diameter
Lochdurchmesser

U-Drill Çapı = 25 mm
Drill Diameter = 25 mm
Vollbohrer Durchmesser = 25 mm

ATUM'un üzerindeki düz çizgi adaptörün sıfır rakamının üzerine konulmalıdır. AET'nin (eksantrik adaptörün) çevrilmesini kolaylaştırmak için AET'nin üzerindeki deliğe, metal bir çubuk ya da vida anahtarını yerleştirilebilir. AET'yi ayarlamadan önce tutucunun vidasını hafifçe çözün.

The adjustment markings should be located perpendicular to the flat on the circumference of the U-DRILL flange. To facilitate the rotation of the adaptor, a metal rod or a screw key may be inserted into a hole on the eccentric adaptor flange. Unlock adapter screw before adjusting adaptor.

Die Einstellmarkierung sollte senkrecht zur Fläche des Bohrerschaftes stehen. Zum Drehen des Adapters sollte ein Stift in die Bohrung am Adapterflansch eingesetzt werden. Lösen Sie die Adapter-Schraube vor dem Einstellen des Adapters.

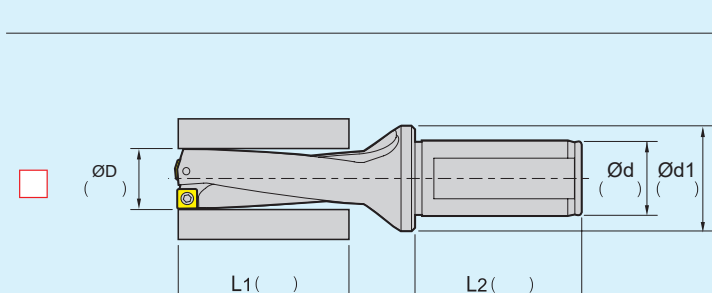
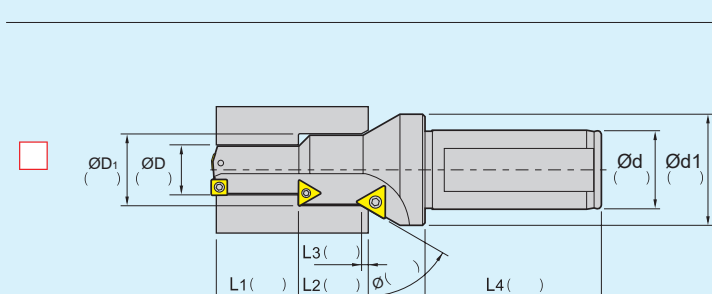
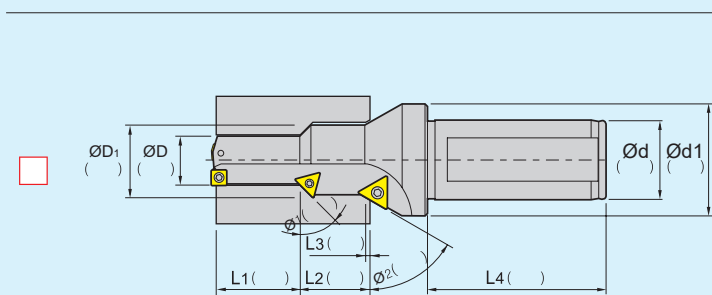
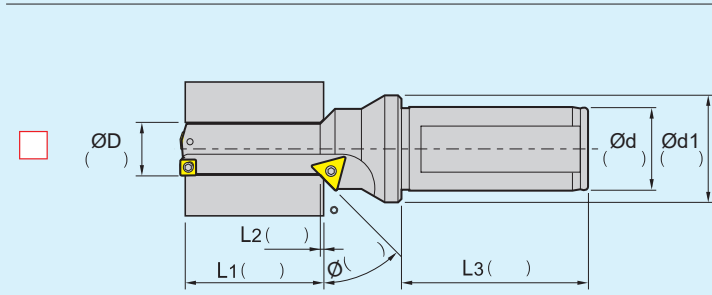
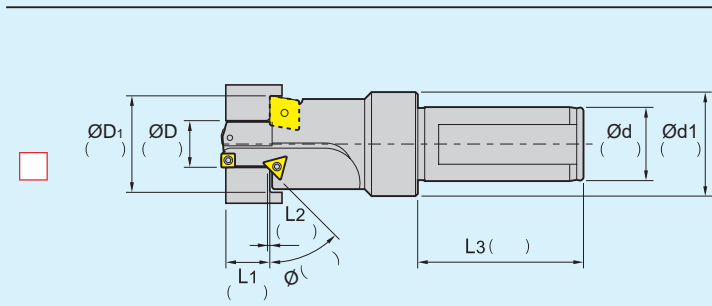

• Soğutma Tipi / Coolant type / Kühlmittelanschluss

Yağ Deliği Dalma Kismında

Oil Hole On the Plunge Part
Kühlmittelzuführung über den Bund

Yağ Deliği Şaft Kismında

"Oil hole On the Shank"
Kühlmittelbohrung durch den Schaft

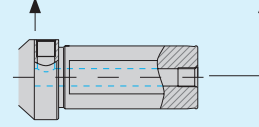

• Delik Tipi / Hole Type / Bohrungstyp

Kapalı Delik

Blind Hole
Grundbohrung

Açık Delik

Thru Hole
Durchgangsbohrung

• Şaft Tipleri / Types of Shank / Schaftausführung

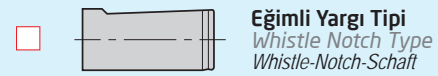
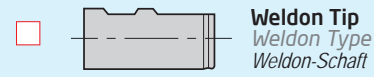
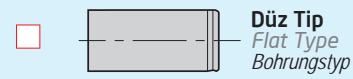

• Yargı Bağlama Yeri / Location of Side Lock / Position der Spannfläche

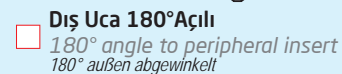
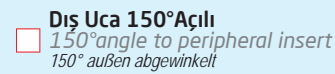
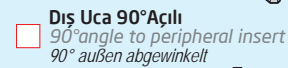

• Not / Note / Hinweis :

- Şu Anki Kullanılan Takım / Currently Using Tool
- Aktuell verwendetes Werkzeug
- Şu Anki Kesme Durumu / Current Cutting Condition
- Aktuelle Schnittbedingungen
 - RPM ya da vc(m/min) / - RPM or vc(m/min)
 - Umdrehungen pro Minute oder vc (m/min.)
 - vf(mm/min) ya da fn(mm/rev)
 - vf(mm/min) or fn(mm/rev) vf (mm/min.) oder fn (mm/Umdr.)
 - Kesme Derinliği / Depth of Cut(mm)
 - Schnitttiefe (mm)
- Ölçülen Standart Takım Ömrü / Standard of Measuring Tool Life
- Standzeit des Werkzeugs
- Şu Anki Kullanılan Makinalar / Currently Using Machine
- Aktuell eingesetzte Maschine
 - İşleme Merkezi / Machining Center
 - Bearbeitungszentrum
 - Genel Torna / General Lathe
 - Drehmaschine
 - CNC Torna / CNC Lathe
 - CNC-Drehmaschine